

## Cordless Woven Natural Shade



**WARNING**

Cords and bead chains can loop around a child's neck and strangle.

- Always keep cords and bead chains out of children's reach.
- Move furniture away from cords and bead chains. Children can climb furniture to get to cords.
- Do not tie cords together. Make sure cords do not twist together and create a loop.

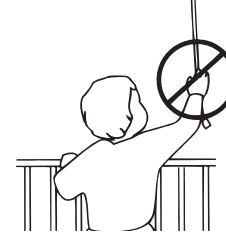

### IMPORTANT INFORMATION ABOUT YOUR ROMAN STYLE NATURAL SHADE

This product is designed to make your shade safer for children and pets. However, this shade is substantially different than the traditional shades that you might be accustomed to. This shade has a double cording system on the back of the shade to help minimize the possibility of a child or pet becoming entangled in the cords.

See the operating instructions toward the back of this handbook for additional information about the function of your shade.

### Color, Materials and Characteristics:

Your woven natural shade is made with materials harvested from nature. Each harvest of natural fibers is unique and will have variations in color, grain, texture, striations and warping. As a result of these inherent qualities, no two shades are identical, nor can they be. Over time, exposure to light will soften and slightly darken the color of the shade. Small cracks in bamboo slats are natural and unavoidable.

### INSTALLATION INSTRUCTIONS

#### Step 1. Check Package Contents

Missing part? Call 1-800-264-1190

Mounting hardware kit includes the following:

| Part   | Quantity                                  |
|--|---|
| Mounting Bracket<br>(includes washer & wing nut) | 2 (up to 54" wide)<br>3 (55" To 72" wide) |
| 1" Screws  | 4 per bracket                             |

#### Step 2. Tools Required

Screwdriver, tape measure, pencil, drill, step ladder

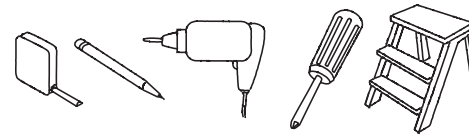

Use a  $\frac{3}{32}$ " drill bit to predrill screw holes.  
Use a  $\frac{1}{4}$ " drill bit for wall anchors.

#### Step 3. Bracket Location and Installation

Your shade may be installed either inside the window frame or outside the window frame.

#### For Outside Mounting:

Place a bracket on both ends of the head rail (and one in the center for larger shades). Hold the shade level at the height

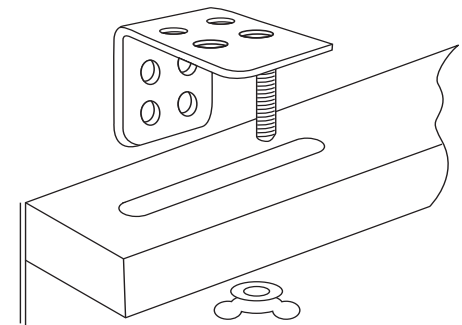
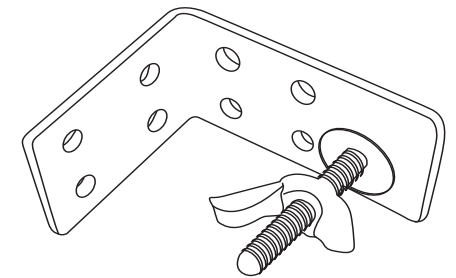

desired and center it over the window opening - mark the exact location of each bracket with a pencil. Remove the brackets from the head rail and position each bracket at the marked location. Mark the location of each screw hole with a pencil.

Predrill the screw holes with a 3/32" drill bit. Screw each bracket into the wall or window molding using the 1" screws.

#### For Inside Mounting:

Place a bracket on both ends of the head rail (and one in the center for larger shades). Hold the shade in place and make a pencil mark at the rear of each bracket where it contacts the inside of the window frame. Remove the brackets from the head rail and align them with the marks. Mark the location of each screw hole with a pencil. Predrill the screw holes with a 3/32" drill bit. Attach each bracket using the 1" screws.

#### Step 4. Securing the Head Rail

Lift the head rail into position – place a washer and wing nut on the post of each bracket – tighten by hand.

#### Step 5. How to Operate

To lower shade: hold the center of the bottom of the shade and pull downward slowly until the shade reaches the desired level.

To lift shade: place your hand (palm facing up) under the bottom of the shade and push upward slowly – if the shade material bunches-up, stop momentarily and then continue pushing upward - do this repeatedly if necessary until the shade reaches the desired height.

#### IMPORTANT

Always push and pull at the center of the shade to assure that the bottom of the shade remains even (i.e. parallel to the top of the shade).

**For wide shades (>48") use two hands, shoulder width apart or wider.**

If the shade becomes uneven, slowly pull it all the way down, and then lift to the desired position. If necessary, reach behind the shade and manually pull the cording slowly out of the head rail until the bottom of the shade is level.

#### CLEANING YOUR SHADES

Use a feather duster or vacuum using the soft brush attachment.

#### REPLACEMENT PARTS

In the event that replacement parts are ever

needed, you may call: 1-800-264-1190  
Please be sure to provide the following information, if possible:

- The complete model or catalog number of your product
- A description of the product
- A description of the part needed

#### LIMITED LIFETIME WARRANTY

The enclosed product is warranted to the original residential retail purchaser as long as the product remains in the original window.

#### Covered:

Lifetime: Entire product against manufacturing defects (i.e. a flaw in the product design, materials, or workmanship that causes the product to no longer function)

3 years: Cords including internal cords such as those found in cordless blinds.

5 years: All fabric

#### Not Covered:

Normal Wear and Tear

Any product that fails due to:

- abuse
- exposure to salt air
- improper installation
- accident
- extraordinary use
- improper operation
- alterations
- improper cleaning
- misapplication
- damage from pests/insects/pets
- improper handling
- misuse

Natural wood products that have:

- loss of color intensity
- yellowing or cracking of plastic parts or foam wood product
- variations in color, grain, or texture
- warping of wood slats in high humidity areas

Costs associated with:

- product removal
- transportation to and from the retailer
- brand label removal
- product remeasure
- incidental or consequential damages
- product reinstallation
- shipping

In the event there are multiple blinds/shades in the same room, only the defective blind/shade will be replaced.

#### To Report Shipping Damage:

If damage occurred during shipping, call place of purchase and report within 7 calendar days or else you may be denied credit for your damaged product.

#### To Obtain Service:

If you suspect this product has a manufacturing defect in materials or workmanship:

1. Locate the sales receipt
2. Call place of purchase

Any unauthorized returns will not be accepted.

#### Warranty Remedy:

THIS SHALL BE YOUR SOLE REMEDY UNDER THIS LIMITED

WARRANTY.

If this product is found to have a manufacturing defect in materials or workmanship, we will (at our discretion) do one of the following

- repair the product
- replace the product
- refund the cost of the product

Colors vary from lot to lot and may not exactly match sample swatch or previous purchases. Discontinued items or color selections will be replaced with the closest equivalent current product.

#### YOUR RIGHTS UNDER STATE LAW:

This lifetime limited warranty gives you specific legal rights, and you may have other rights, which vary from state to state. Some states do not allow limitations on how long a warranty lasts, so the above limitations may not apply to you.

No agent, representative, dealer, or unauthorized employee has the authority to increase or alter the obligation of this warranty. This lifetime limited warranty supersedes any previous versions.

For all questions, please call  
(800) 264-1190

Hours of operation are  
8:00am to 5:00pm CST

The logo for SelectBlinds, featuring a stylized window blind icon above the brand name "SelectBlinds" in a large, bold, sans-serif font.

## LIMITED LIFETIME WARRANTY

The enclosed product is warranted to the original residential retail purchaser as long as the product remains in the original window.

### Covered:

Lifetime: Entire product against manufacturing defects (i.e. a flaw in the product design, materials, or workmanship that causes the product to no longer function)

**3 years:** Cords including internal cords such as those found in cordless blinds.

**5 years:** All fabric

**5 Years:** Battery Operated Motors

### Not Covered:

Normal Wear and Tear

### Any product that fails due to:

- abuse
- exposure to salt air
- improper installation
- accident
- extraordinary use
- improper operation
- alterations
- improper cleaning
- misapplication
- damage from pests/insects/pets
- improper handling
- misuse

### Natural wood products that have:

- loss of color intensity
- yellowing or cracking of plastic parts or foam wood product
- variations in color, grain, or texture
- warping of wood slats in high humidity areas

### Costs associated with:

- product removal
- transportation to and from the retailer
- brand label removal
- product remeasure
- incidental or consequential damages
- product reinstallation
- shipping

In the event there are multiple blinds/shades in the same room, only the defective blind/shade will be replaced.

### To Report Shipping Damage:

If damage occurred during shipping, call place of purchase and report within 7 calendar days or else you may be denied credit for your damaged product.

### To Obtain Service:

If you suspect this product has a manufacturing defect in materials or workmanship:

1. Locate the sales receipt
2. Call place of purchase

Any unauthorized returns will not be accepted.

### Warranty Remedy:

THIS SHALL BE YOUR SOLE REMEDY UNDER THIS LIMITED

WARRANTY.

If this product is found to have a manufacturing defect in materials or workmanship, we will (at our discretion) do one of the following

- repair the product
- replace the product
- refund the cost of the product

Colors vary from lot to lot and may not exactly match sample swatch or previous purchases. Discontinued items or color selections will be replaced with the closest equivalent current product.

### YOUR RIGHTS UNDER STATE LAW:

This lifetime limited warranty gives you specific legal rights, and you may have other rights, which vary from state to state. Some states do not allow limitations on how long a warranty lasts, so the above limitations may not apply to you.

No agent, representative, dealer, or unauthorized employee has the authority to increase or alter the obligation of this warranty. This lifetime limited warranty supersedes any previous versions.

For all questions, please call (800) 264-1190  
Hours of operation are 8:00am to 5:00pm CST

## Motorized Woven Natural Shade

### Installation & Operating Instructions

#### INSTALL THE SHADE BEFORE ATTEMPTING TO OPERATE THE MOTOR.



WARNING

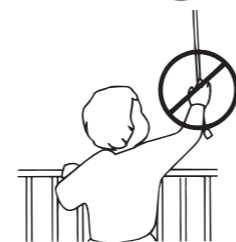

Cords and bead chains can loop around a child's neck and strangle.

- Always keep cords and bead chains out of children's reach.
- Move furniture away from cords and bead chains. Children can climb furniture to get to cords.
- Do not tie cords together. Make sure cords do not twist together and create a loop.

#### IMPORTANT INFORMATION ABOUT YOUR ROMAN STYLE NATURAL SHADE

This product is designed to make your shade safer for children and pets. However, this shade is substantially different than the traditional shades that you might be accustomed to. This shade has a double cording system on the back of the shade to help minimize the possibility of a child or pet becoming entangled in the cords.

See the operating instructions toward the back of this handbook for additional information about the function of your shade.

#### Color, Materials and Characteristics:

Your woven natural shade is made with materials harvested from nature. Each harvest of natural fibers is unique and will have variations in color, grain, texture, striations and warping. As a result of these inherent qualities, no two shades are identical, nor can they be. Over time, exposure to light will soften and slightly darken the color of the shade. Small cracks in bamboo slats are natural and unavoidable.

### INSTALLATION INSTRUCTIONS

#### Step 1. Check Package Contents

Missing part? Call 1-800-264-1190

Mounting hardware kit includes the following:

| Part   | Quantity   |
|--|--|
| Mounting Bracket<br>(includes washer & wing nut) | 2 (for shades up to 48" wide)<br>3 (for shades up to 72" wide) |
| 1½" Screws                                       | 4 per bracket  |
| Radio Frequency Remote                           | 1  |
| Wall Holder for Remote                           | 1  |

*Wallboard or Plaster: use anchors specifically designed for hollow walls (not included).*

*Concrete, Stone, Brick: use a masonry drill bit and anchors or screws specifically designed for masonry (not included).*

#### Step 2. Tools Required

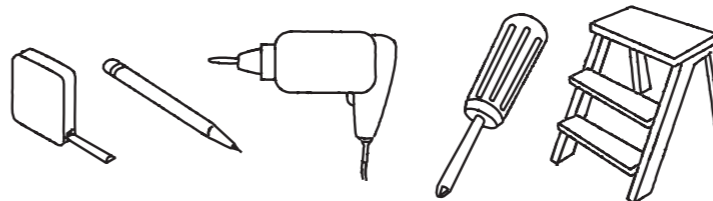

Screwdriver, tape measure, pencil, drill, step ladder, spirit level.

*Note: use a 3/32" drill bit to pre-drill the screw holes (for attachment to a wall stud or header board). Use Wall Anchors (not included) for hollow dry wall or plaster mounting*

#### Step 3. Bracket Location and Installation

Your shade may be installed either inside the window frame or outside the window frame.

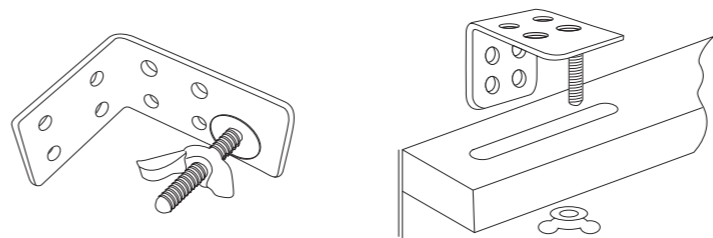

#### For Outside Mounting:

Place a bracket on both ends of the head rail (and one in the center for larger shades – note that the center support bracket has a shorter post than the outer brackets).

Hold the shade at the height desired and center it over the window opening. The brackets must be level – use a Spirit Level if necessary to assure proper alignment. Mark the exact location

of each bracket with a pencil. Remove the brackets from the head rail and position each bracket at the marked location. Mark the location of each screw hole with a pencil.

Predrill the screw holes with a 3/32" drill bit. Screw each bracket into the wall or window molding using the 1½" screws.

#### For Inside Mounting:

Place a bracket on both ends of the head rail (and one in the center for larger shades – note that the center support bracket has a shorter post than the outer brackets).

Hold the shade in place and make a pencil mark at the rear of each bracket where it contacts the inside of the window frame. Remove the brackets from the head rail and align them with the marks. Mark the location of each screw hole with a pencil. Predrill the screw holes with a 3/32" drill bit. Attach each bracket using the 1½" screws.

#### Step 4. Securing the Head Rail

Lift the head rail into position – place a washer and wing nut on the post of each bracket – tighten by hand.

#### Step 5. IMPORTANT FINAL STEP BEFORE OPERATION

Remove the Tape From the Roller Tube - Carefully peel off the tape covering the lift cords on the tube (see illustration)

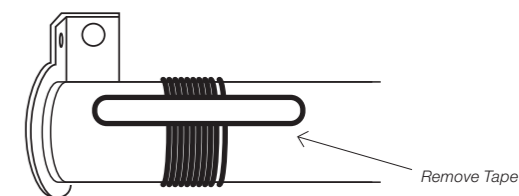

#### Step 6. Operating the Shade

### PROGRAMMING AND OPERATION OF RADIO TECHNOLOGY MOTORS

Activating the motor: Press the program button for 1 second – the Red indicator light will flash – the motor is now "ON"

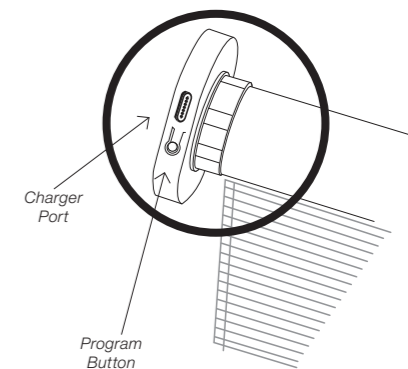

**IMPORTANT:** The Upper & Lower limit positions (full UP & DOWN positions) have been pre-set at the factory – also, a Channel Number has been assigned to each shade - therefore, it is not necessary to perform Steps 1, 2 & 3 below – however, we recommend that you read these to familiarize yourself with the basics of programming the motor and remote control and to fully understand the function of your motorized shade. Also, note that the batteries in the motor are fully charged at the factory prior to shipment.

**1. Channel Selection for Each Shade**

*When you receive your shades the channel number pre-assigned to each shade will be marked on the shade and/or carton. Per the notice above, it is not necessary to perform Steps 1, 2 & 3 as these settings are done at the factory and will require no adjustment under normal circumstances.*

A channel number must be assigned to each motor/shade. The assigned numbers should be sequential starting with #1 (1, 2, 3 etc.).

Press the channel buttons/arrows to select a dedicated channel for each shade prior to mating each shade/motor to the remote controller.

**2. Programming/Mating**

**REMINDER:** *the motor and remote have been pre-set at the factory – programming information for Steps 1, 2 & 3 is provided as background information only.*

Identify the head of the motor housing on the left side of the shade (see drawing) - Press the PROGRAM button until the shade oscillates (the shade will oscillate - a quick back and forth movement of the shade) Press the UP button on the remote (see drawing) – the shade will oscillate again – the motor and transmitter are now mated.

**3. Setting UP and DOWN Limit Positions**

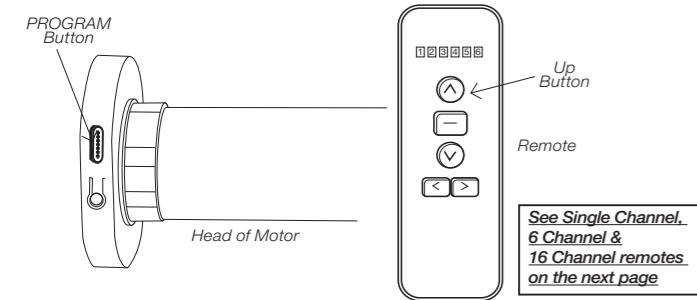

**NOTE:** *Upper and lower limit positions have been pre-set at the factory - programming information for Steps 1, 2 & 3 is provided as background information only.*

**Set the UP position:**

Move the shade 6” to 10” below the desired upper limit by pressing the UP or DOWN arrows/buttons on the remote. Press the PROGRAM button on the back of the remote – the motor will oscillate – this puts the motor in program mode. Now move the shade up to the desired UP position and press the program button again – the motor will oscillate and the upper limit is now set.

**Set the DOWN position:**

Move the shade down from the upper limit position to a point 6” to 10” from the bottom, and then press the PROGRAM button on the back of the remote – the motor will oscillate and is once again in program mode.

Now move the shade to the desired DOWN position and press the PROGRAM button the motor will oscillate and the lower limit is now set.

**NOTE:** *after all limits are set, see the remote control operating instructions below.*

**4. Setting Intermediate Positions & Other Settings**

**Setting INTERMEDIATE positions**

Up to (4) intermediate positions can be set.

Move the shade at least 6 inches away from the previously set limits – press the PROGRAM button on the rear of the remote – the motor will oscillate and is now in program mode.

Now move the shade to any desired intermediate STOP position and press the PROGRAM button again – the motor will oscillate and the intermediate STOP position is now set.

Repeat this process to set additional intermediate STOP positions.

When setting a limit, if there is no action within 30 seconds, the motor

**Remote Transmitters**

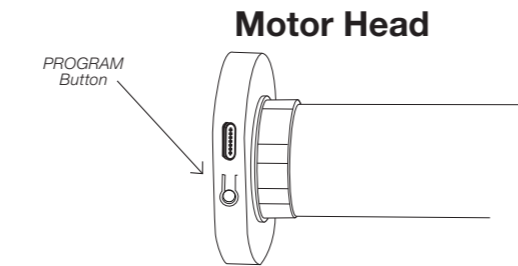
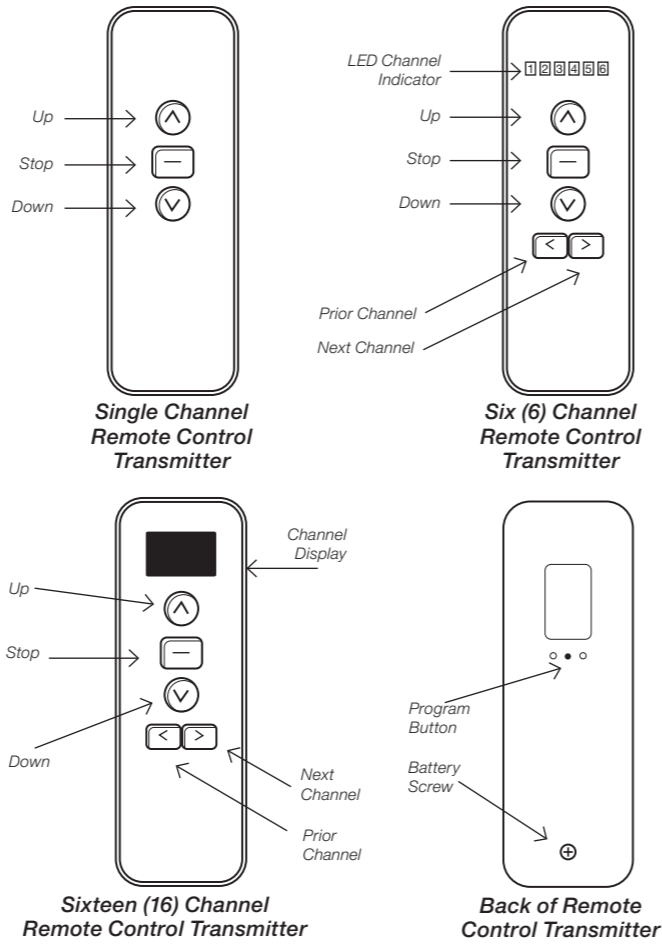

will automatically exit the limit programming mode.

**Limit Position Fine Tuning:** move the shade to the limit position that you wish to adjust. Press the program button on the rear of the remote – the motor will oscillate and is now in limit setting mode. Use the UP/DOWN buttons on the remote to establish a new position – press the program button on the rear of the remote – the motor will oscillate and the fine-tune setting is now complete.

**Erasing Limits:**

**Note:** *the 1st/Upper limit cannot be erased – it can only be eliminated by deleting all memory*

Move the shade to the limit position that you wish to erase – press and hold the PROGRAM button on the rear of the remote for approximately 7 seconds – the motor will oscillate twice, and the limit has been erased.

**Deleting Memory**

**To Delete All Memory:** Press the program button on the head of the motor 4 times (@ one second intervals), press once, wait for the LED to flash RED – press a 2nd time, wait for a flash – press the 3rd time, wait for 2 flashes – press the 4th time, wait for 2 flashes, the motor will oscillate. All memory is now erased.

**Deleting Memory for a Single Channel:** Set the remote transmitter on the channel to be deleted. Press the STOP button for approximately 5 seconds – the motor will oscillate. Now press the program button on the rear of the remote – the motor will oscillate and the single channel is deleted

**Using the Remote Control Transmitter**

Press the UP/DOWN button once and the shade will move to the next pre-set limit position.

Press the UP/DOWN button twice at the speed of once per second and the shade will move to the UP or DOWN limit position without stopping at any intermediate position.

When the up position has been reached, the UP button becomes non-functional, and when the down position has been reached the DOWN button becomes non-functional.

**Controlling Multiple Shades Simultaneously**

**6 Channel Remote:** press the channel selector until all six lights are lit to control up to 6 shades at the same time using the remote control as described above.

**16 Channel Remote:** press the channel selector button until “CC” appears in the display window to control up to 16 shades at the same time using the remote control as described above.

**Operating the Shade**

To raise and lower the shade, use the remote control as described above.

**Charging the Batteries**

Connect the AC Charger to the Charger Cable attached to the motor head – charge for 8 hours.

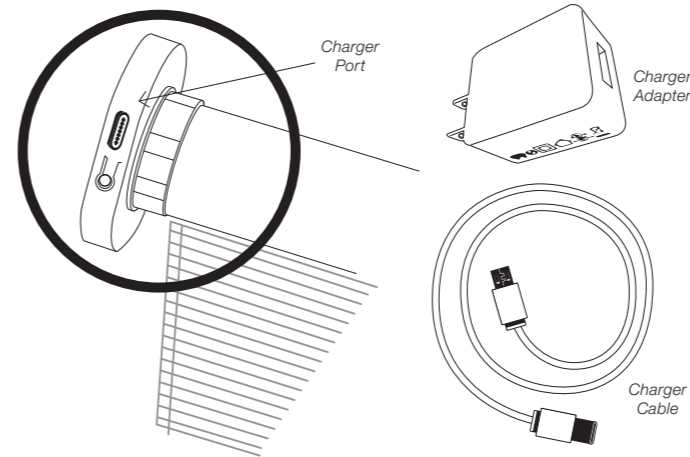

**NOTE:** *Each battery/motor should be charged at least once every 6 months.*

**Installation/Replacement of the Remote Control Battery**

Remove the cover on the rear of the remote by removing the screw and sliding the back plate upward slightly – install a 3V [CR2032] disk type battery as illustrated.

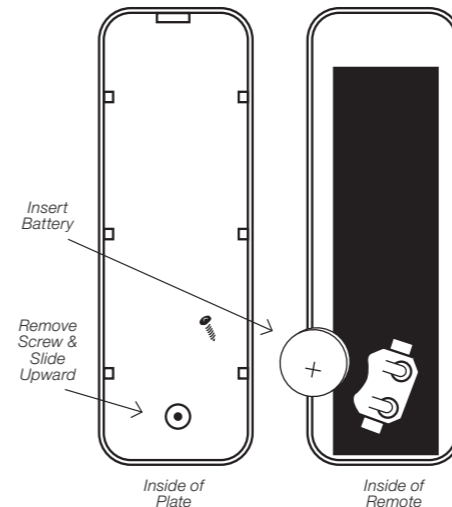

**Installation of Optional Wall Mount Holder**

Attach the remote holder using the screws provided (use wall anchors for hollow dry wall), or peel the foil off the adhesive pad on the back of the remote holder and press it into place on any clean flat surface.

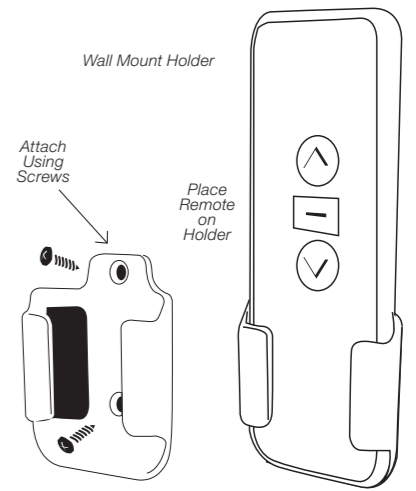

**CUSTOMER SERVICE: 1-800-264-1190**

**General Safety Instructions for Motorized Shades**

- Do not expose the motor or transmitter to moisture or extreme temperatures
- Do not allow children to play with this device
- Use or modification outside the scope of this instruction manual will void the warranty
- If cable or power connector is damaged, do not use

**Important Information about your battery powered product:**

Rechargeable batteries should be recycled, not disposed of with common household trash. When/if you replace your shade, please recycle in accordance with local environmental regulations. This also applies to the button type battery in the remote control(s).

**Statement Regarding FCC Compliance**

This device complies with Part 15 of the FCC rules. Operation is subject to the following two conditions:

- 1) This device may not cause interference, and
- 2) This device must accept any interference received, including interference that may cause undesired operation.

**Note:**

This equipment has been tested and found to comply with Part 15 of the FCC Rules. These limits are designed to provide reasonable protection against harmful interference in a residential installation. This equipment generates, uses and can radiate radio frequency energy and, if not installed and used in accordance with the instructions, may cause harmful interference to radio communications.

However, there is no guarantee that interference will not occur in a particular installation. If this equipment does cause harmful interference to radio or television reception, which can be determined by turning the equipment off and on, the user is encouraged to try to correct the interference by one or more of the following measures:

- Increase the separation between the equipment and the receiver.
- Connect the equipment into an outlet on a circuit different from that to which the receiver is connected.
- Consult the dealer or an experienced radio/TV technician for help.

Any changes or modifications not expressly approved by the party responsible for compliance could void the users authority to operate the equipment.

**CLEANING YOUR SHADES**

Use a feather duster or vacuum using the soft brush attachment.

**REPLACEMENT PARTS**

In the event that replacement parts are ever needed, you may call: 1-800-264-1190

Please be sure to provide the following information, if possible:

- The complete model or catalog number of your product
- A description of the product
- A description of the part needed