

CORDLESS ALUMINUM MINI-BLINDS

INCLUDED PARTS

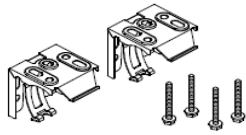

Brackets & Bracket Screws
Qty: 2-4 (depending on size of blind)



Pull Handle
Qty: 1



Wand
Qty: 1

TOOLS NEEDED

Drill with bits, Metal tape measure, Screwdriver, Pen

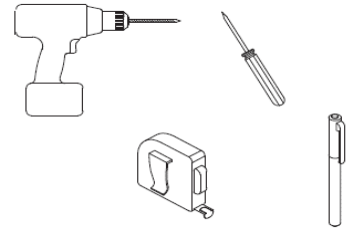

OPTIONAL PARTS (available for purchase)

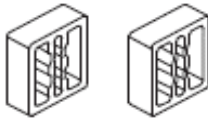

Spacers
Qty: 2-4 (depending on size of blind)

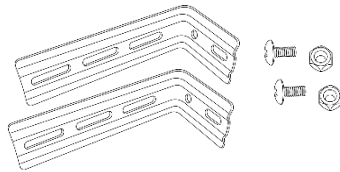

Extenders & Extender Screws/Nuts
Qty: 2-4 (depending on size of blind)

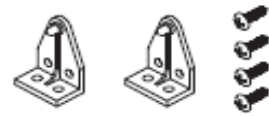

Bottom Clips & Screws
Qty: 2 Baskets, 4 Screws

1. INSTALL THE BRACKETS

- Please read this entire step before installing your Brackets
- Mark the Bracket locations, making sure that the Brackets will not interfere with any mechanism or other internal headrail parts. The outermost Brackets should be installed approximately 1/4 inch from each end of the blind. If you have more than two (2) Brackets, all remaining Brackets should be installed near the center of the blind.
- Before installing your Brackets, determine if you need to use Spacers (sold separately) and/or Extenders (sold separately).
- Spacers increase the distance between the aluminum blind and the installation surface. To use Spacers, place the Spacer between the Bracket and the installation surface using the bracket screws (Fig A).
- Extenders are used to provide space between the installation surface and the aluminum blind. To use Extenders, install the Extender on the installation surface using the Bracket Screws. Then, attach the Brackets to the Extender using the provided Extender Screws (Fig B).

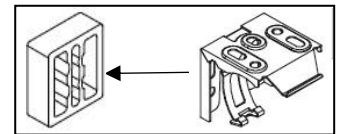

Fig A.

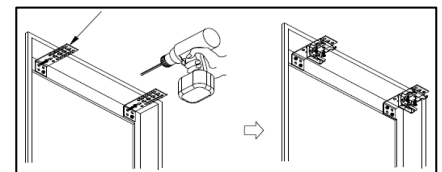

Fig B.

2. ATTACH THE BLIND

- Position the headrail with its front lip resting on the top hooks of all Brackets, then push the bottom of the headrail firmly upwards until the groove at the bottom of the headrail snaps into place (Fig C).

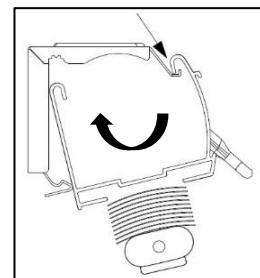

Fig C.

3. ATTACH THE WAND

- Attach the Wand on the wand hook located on the headrail (Fig D).

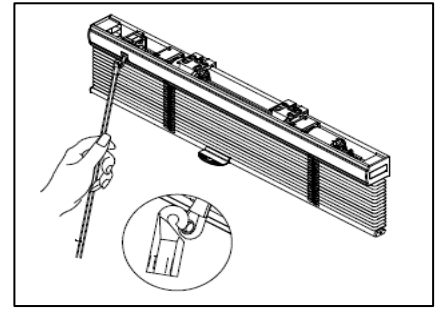

Fig D.

4. ATTACH THE BOTTOM CLIPS (optional - sold separately)

- The Bottom Clips are optional and sold separately.
- For an outside mount, install the Bottom Clips to the wall (Fig E.).
- For an inside mount, install the Bottom Clips to the jamb of the window frame (not the sill) (Fig E).

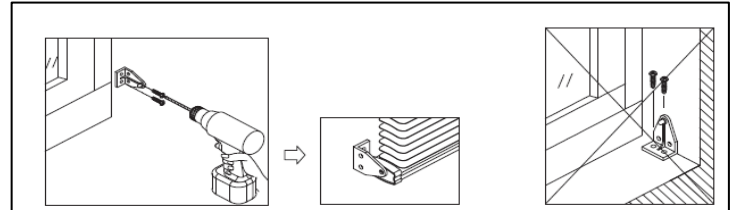

Fig E.

HOW TO REMOVE THE BLIND FROM THE BRACKETS

- Use a flat head screwdriver to release the blind from the Bracket (Fig F).

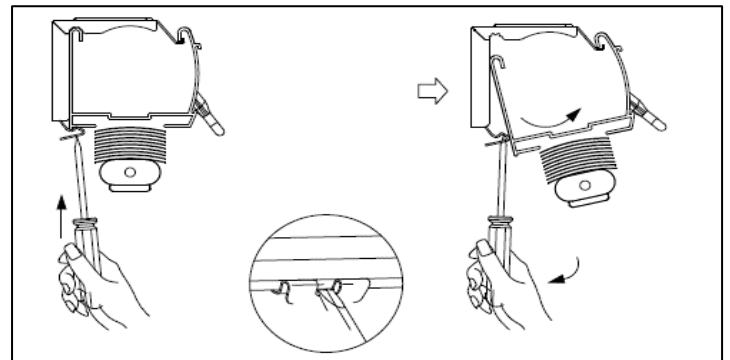

Fig F.

CARE AND CLEAN

- Dust the blind with a soft dust cloth or dusting mitt; or vacuum with a soft brush attachment
- Clean the blind with non-abrasive sponges or cloth, using water or non-abrasive detergent. Never use hot water, solvents, or abrasive/harsh cleaners.