

SelectBlinds™ Automation

Roller & Solar Shades with
Internal Rechargeable Battery

User Guide



Contents

Installation	3
Deactivate Ship Mode	3
Set-Up Shades and Accessories in the App	4
Download or Update the SelectBlinds Automation App	4
Sign In or Create Account	4
Add Shades	4
Add Remotes	5
Add Scenes	5
Add Timers	6
Add Bridge.....	6
Charging Shades	7
Remote Control Guide	10
Getting Started.....	10
Installing a Wall Mount Kit	11
Programming.....	12
Basic Operation	13
Remote Operation for Roller and Solar Shades	13
LED Display Behavior	14
Battery Replacement.....	14
Bridge Guide	15
Components	15
View	15
Placement in the Home	16
Quick Start Instructions	16
Troubleshooting	17
Home Automation Integration	18
Use Voice Commands to Operate Shades.....	19
Apple Home — Tips and Tricks	20
Google Home — Tips and Tricks	21
Amazon Alexa — Tips and Tricks.....	21
Declarations	22
Motor and Remote Declarations	22
Bridge Declarations	23
PowerWand™ Quick Programming Guide	24
Honeycomb Shades, Roller/Solar Shades, Sheer Shades, and Zebra Shades	24

Installation

For detailed installation instructions, reference the [Roller or Solar Shades Installation Guide](#).

ⓘ IMPORTANT: Shades with a cassette top treatment will include a customized cardboard insert on the idle side. This insert prevents the shades from shifting and causing damage during transit. Tape may have also been applied to the cardboard and plastic end cap as shown below.

Please follow these steps when ready to install your Roller or Solar Shade with Cassette:

1. Remove the tape from the plastic end cap. An example of blue tape can be seen in the image to the left, but the color may vary.
2. Hang the shade in place.
3. Pull the cardboard insert straight down from the idle side.



Deactivate Ship Mode

SelectBlinds Automation Roller & Solar Shades must be put to sleep to ship to you safely. As such, shades arrive asleep in “Ship mode.” After installing the shade in the window, you will need to deactivate ship mode before you can operate the shade. To deactivate ship mode, please complete the following steps:

1. Press and release the control button (located on the shade headrail) 3 times in quick succession. The LED color will change with each press. Use a flathead screwdriver or similar tool to access the button if necessary.
2. When the LED turns dark blue, ship mode has been deactivated.

After deactivating ship mode, you can press and release the control button again to test operation.

📄 NOTE: The shade will return to ship mode after two hours. To prevent this, set up the shade in the SelectBlinds Automation app or leave the shade at least 10% closed.

- To connect the power from the charging port to the solar panel, see the Installation section of the [Solar Panel Installation Guide](#).

ⓘ IMPORTANT: Each shade’s internal battery arrives partially charged. After following the steps below to set up your shades in the app, please make sure to fully charge your automated shades before use.



Set-Up Shades and Accessories in the App

Set-up begins in the SelectBlinds Automation App. Follow the steps below to download the app, create an account, and add shades and accessories.

Download or Update the SelectBlinds Automation App

- If the app is not installed, download it on your smartphone: www.getselectapp.com.
- If the app is already downloaded on your device, make sure your app is up-to-date.

Sign In or Create Account

An account is required to set up and access your automated shades.

1. Open the app.
2. Create an account or sign in.
3. Follow the prompts to enter all required information to verify your account.

Add Shades

After the shades have been installed and powered on, they can be added to your home in the app.

NOTE: If your shades are equipped with an internal rechargeable battery, you will need to deactivate ship mode before adding the shades to the app. Refer to [“Deactivate Ship Mode” on page 3](#).

1. Select “Add shades” from the “Rooms” tab.
 - NOTE:** During initial set-up, this option can also be found on the “Scenes” and “Timers” tabs. Once shades have been added to the “Home”, navigate to “Manage shades” from the menu on the rooms tab to add more shades.
2. Name your “Home”. Any shades you add will then be grouped under this virtual “Home” in the app.
3. Next, you’ll see a list of available shades. These are organized by proximity, so that shades closest to you would appear towards the top of the shade list. Pull down from the top of the screen to refresh shade order.
4. Set up one shade at a time. To identify a shade, select “Jog” to move a shade slightly up and down. Once identified, select “Set up” to continue.
 - Selecting “Set up” brings you to “Shade settings.” Enter a name for the shade and add it to a room.
 - ◊ When naming the shade, we recommend entering a location-related shade name to help you easily identify it in the app. For example, “Left,” “Right,” “Middle,” “Upper,” or “Lower,” etc.
 - ◊ When adding a shade to a room, you can create a new room or add the shade to an existing room.
 - ◊ When creating a room, enter a custom name and image, or choose “Select from suggested” to choose from a list of frequently created rooms.
 - Shades equipped with the Internal Rechargeable Battery should have information pre-populated under “Power option”. If you also have a solar panel, click on the “Power option” to further customize.
 - There are other required settings for a shade that may need attention, if they do not have a value or selection already. These settings will be marked as “Required” in the app, and will include:
 - ◊ Product type
 - ◊ Limits
5. When you are done setting up a shade, you will be brought back to the “Manage shades” list. Repeat this process until you have added all the desired shades, then tap “Done” to return to the rooms tab.

NOTE: Tap the menu in the upper right-hand corner and select “Manage shades” to return to your shades list. This may be helpful if you want to adjust settings or add new shades later.

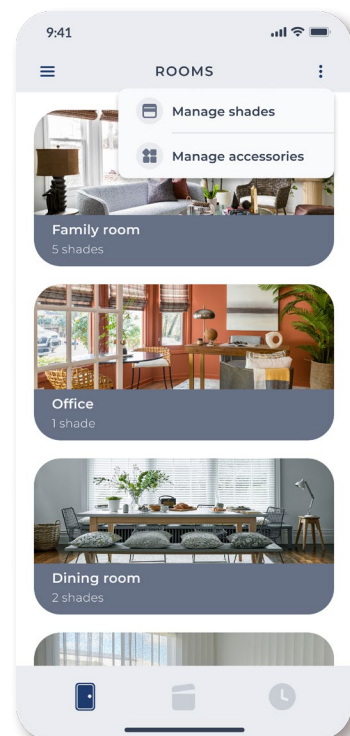
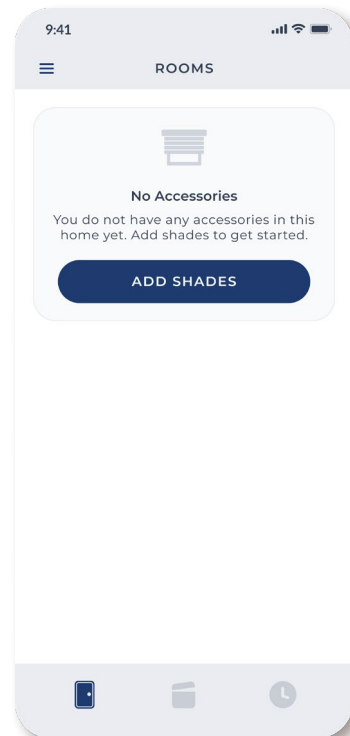

Add Remotes

Remotes are also programmed in the app. Follow the instructions listed below to set up a remote.

NOTE: For more information on getting started with the remote, reference the Remote Control Guide section.

1. Tap the menu in the upper right-hand corner on the rooms tab, and then select “Manage accessories” to add a remote.
 - You can also add a remote by selecting “Accessories” from the menu in the left-hand corner on any tab. If you do not have any remotes, you can skip this step.
2. Tap the plus button and then choose “Add remote” to add a new remote.
3. Name the remote.
 - If you will be adding multiple remotes to this “Home”, we recommend naming the remote with the room name or some other identifiable indicator. This will allow you to easily identify remotes when updating programming.
4. Configure the remote.
 - The configuration page in the app shows all remote group numbers 0-5 in a carousel display.

NOTE: “0” is an all-shades group, so you do not need to select it during the programming process. All shades added to groups 1-5 will appear under group 0 automatically.

 - Choose the desired group number (1-5) and then choose the shades to assign to that group. Repeat this for all desired shades and group numbers.
 - Tap “Link” and follow the in-app instructions to synchronize the settings you created to the physical remote. When linking is complete, a “Remote linked!” message will appear in the app. Tap “Done” to return to the “Accessories” list, with the new remote shown.
5. Repeat the steps above to add any additional remotes.

For more information on remote operation, reference the [“Remote Control Guide” on page 11](#).

NOTE: A maximum of 10 unique shades can be added per remote to ensure optimal performance.

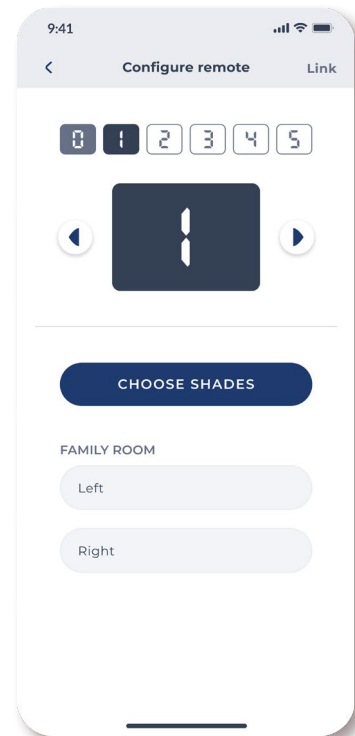

Add Scenes

Set the mood and enhance your environment by controlling the natural light in the room using “Scenes.” Create customized scenes to control a selection of shades in a single room or across multiple rooms. For example, you could create scenes such as:

- “Living room open” to move all shades in the living room to the open position.
- “Nighttime” to close all the window treatments in the house.

The possibilities are endless! To create a new scene, follow the instructions below:

1. Navigate to the “Scenes” tab and tap the plus (+) button.
2. Select an image.
3. Name the scene.
4. Tap “Choose shades,” and select the desired shades from the list.
5. Confirm shade position.
 - Current shade positions will automatically be saved as the scene position. If you are happy with the current positions, simply tap “Done” to dismiss the “Choose shades” screen, then tap “Save” to finalize the scene.
 - To modify the shade position for your scene, select each desired shade, one by one, and manually adjust the position as desired. Then tap “Done” to save the set positions.
6. Repeat these steps for any additional scenes.

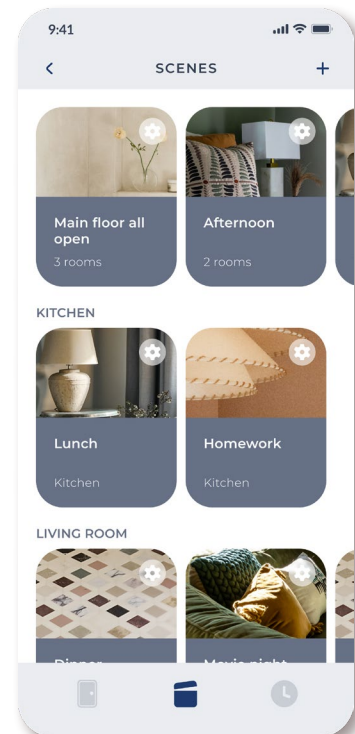

Add Timers

Schedule “Timers” for more intuitive control of scenes, activating specific scenes based on the time of day. Timers are designed to work with your everyday life without having to lift a finger.

1. Navigate to the Timers tab to create a timer.
2. Tap the plus (+) button located in the upper right corner.
3. Choose the scene that you would like to schedule. You can choose any existing scene in the home.
4. Tap on “Set schedule” and select the days of the week you would like this timer to activate. Then select when you would like this timer to occur.
 - You can choose a specific time, or a time based on your local sunrise or sunset.
 - For example, you can set up a “Good morning” scene to activate at 8:00 am on Mondays through Fridays. Or you can program a “Good night” scene to activate 30 minutes after sunset.

NOTE: Location permissions must be enabled for any sunrise or sunset timers, so the app can access your local sunrise and sunset times.

5. Tap “Done” to save the timer.

All timers will appear on the Timers tab after they are saved. You can easily enable or disable timers at any time. This may be helpful when traveling, on holidays, etc.

Add Bridge

The bridge is an optional piece of hardware used to provide additional features and benefits, including integrating your smart shades with the popular home automation systems and allowing you to control your shades remotely, from anywhere in the world.

NOTE: For more information on the features and benefits of the bridge, getting started, and troubleshooting, reference the [Bridge Guide](#). We recommend adding the bridge after all shades have already been added to the home.

To add a bridge to your installation, follow the instructions below:

1. Tap the menu in the upper right-hand corner of the rooms tab and then select “Manage accessories.”
 - You can also add a bridge by selecting “Accessories” from the menu in the upper left-hand corner on any tab.
2. Tap the plus (+) button, then choose “Add bridge” to add a new bridge device to your home.
 - Before adding a bridge, we recommend all shades are added to the home, and the bridge is powered on and blinking green or green + purple.
3. Under “Bridge Settings,” name the bridge.
4. Configure the Wi-Fi connection.
5. Next, the app will assign shades to the bridge, and will verify if the position of the bridge is within an acceptable range of the shades.
 - If the bridge position is not in an acceptable range of all shades, you will be informed which rooms of shades could not be assigned. You may then try to reposition the bridge.

If the bridge location is moved, Wi-Fi is updated, or shades are removed and/or added, you can modify bridge settings in the app.

IMPORTANT: A single bridge can connect up to 15 shades. Currently, the system only supports one bridge per home, so you will not be able to add additional bridges. Support for additional bridges will be coming in 2026.

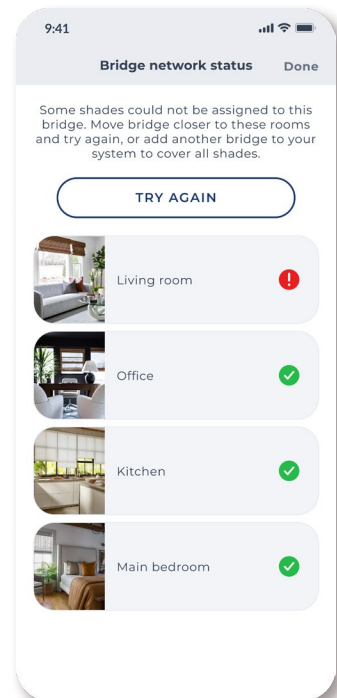
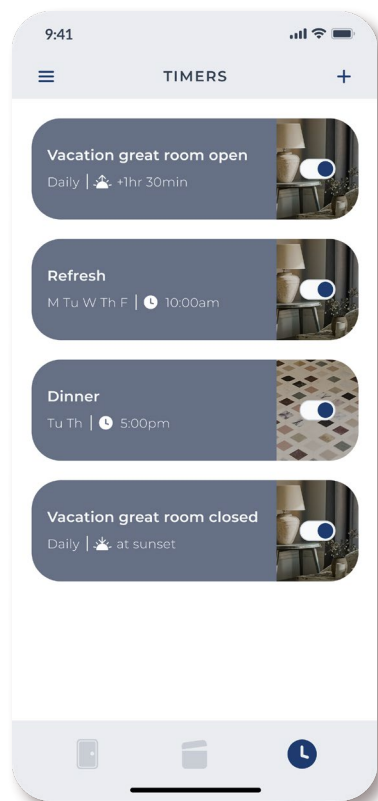

Charging Shades

IMPORTANT: Your shade's internal battery arrives partially charged. Please make sure to fully charge the battery before use, after setting up your shade in the app. During initial set-up, the app will also let you know if the battery level is low, and if so, will recommend that you charge it.

You can check battery status in the app, after your shades are set up. To view battery level, navigate to "Shade settings" ("Rooms" > "Shades" > Select the desired shade > Shade settings), as pictured at right.

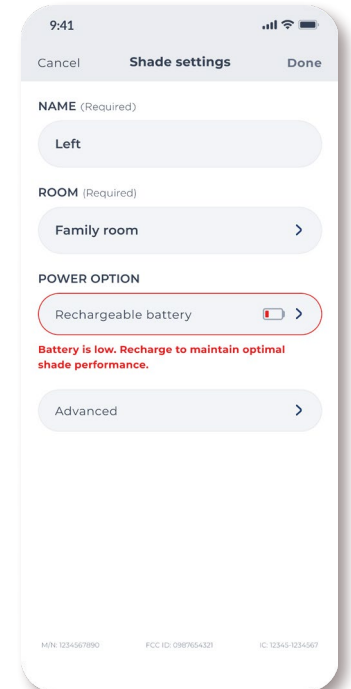
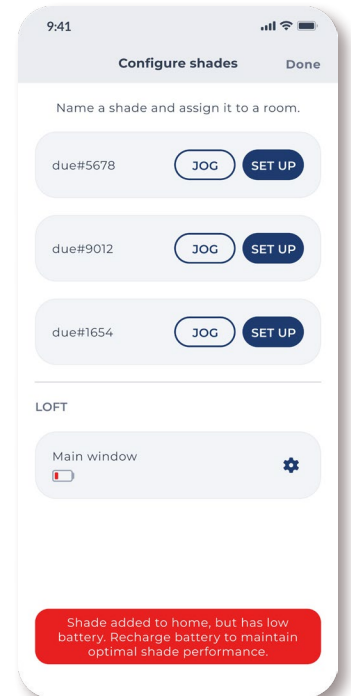

SelectBlinds™ Automation | Roller & Solar

To charge your shades, follow the steps below.

1. Attach the charging block to the male end of the provided USB-C cable.
 - The charging kit comes with a 120" cable assembly. An additional charging extension cable can also be added to create additional length, if necessary.
 - If you have the optional Magnetic Charging Kit, connect the 24" magnetic charging cable to your charging cable assembly.



2. Plug the charger into a standard AC outlet.
3. Connect the USB-C male end of the cable into the charging port.
 - The main charging port is located on the motor side of the shade, near the control button.



SelectBlinds™ Automation | Roller & Solar

- Alternatively, if you have the optional Magnetic Charging Kit, connect the magnetic charging tip to the charging port instead, and next connect the magnetic end of the charging cable to the magnetic charging tip inserted in the charging port.



- This charging port can also be used to connect the optional solar panel. If you are installing your shade with a solar panel, please reference the installation instructions [HERE](#).
 - You can adjust your shade's LED behavior during charging in "Shade settings" in the app. Under "Power option," select "Internal rechargeable battery" to see your options. You can select "Solar panel" or toggle the LED on or off. If you enable the "Solar panel" option, you will not see the LED behavior related to charging.
4. Charging your shade will take approximately seven (7) hours. We recommend charging overnight for convenience.
- The LED indicator on the front of the shade (located near the control button) will blink green when charging. It will turn to a solid green when charging is complete.
 - You can open the app and check "Shade settings" to confirm the battery level is back to green.
- ⓘ IMPORTANT:** To ensure optimal charging, please use the charging cables and power blocks provided by SelectBlinds. Using alternate chargers may result in your shade battery not charging.

Remote Control Guide

Getting Started

Your SelectBlinds Automation remote comes with 2 AAA batteries. Install your batteries before programming and operation.

1. Open the battery compartment on the back of the remote by sliding it upward, as pictured below.
2. Insert the AAA batteries, being careful to match the positive (+) end of the battery with the positive (+) terminal in the device and the negative (-) end of the battery with the negative (-) terminal in the device.
3. Slide the battery cover back into place.

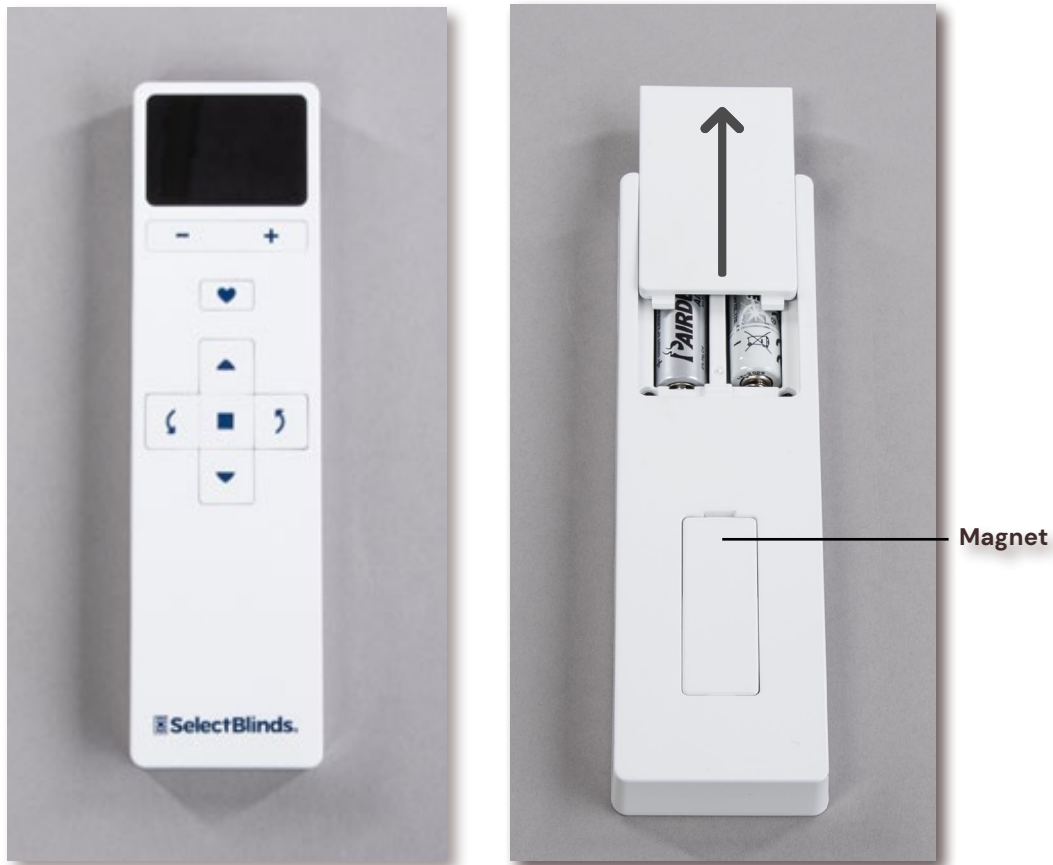

Installing a Wall Mount Kit

If you would like to mount your remote on the wall, an optional wall mount kit is available for purchase. To install the wall mount, follow the instructions below.

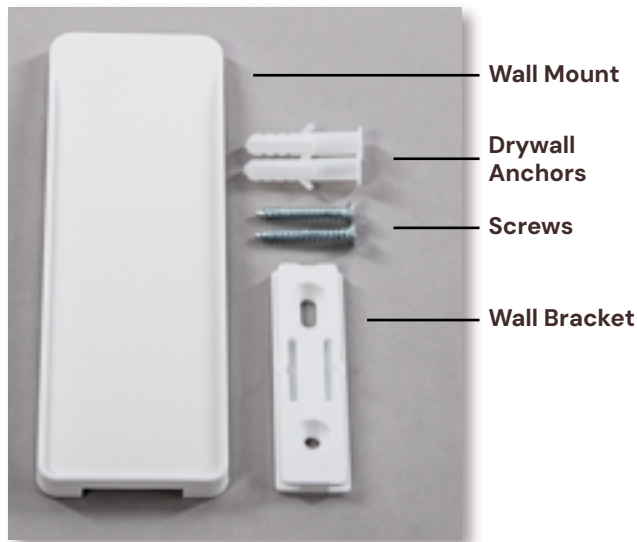

1. Determine the mounting location. Place the wall bracket on an appropriate mounting surface and mark the location of the mounting holes with a pencil. Make sure to consider the size of the wall mount (pictured on the next page) to ensure you have enough mounting space.



2. Determine how you are going to install the wall bracket. There are two options.
 - You can choose to install with the two screws (size M 3.5x25 galvanized) and drywall anchors provided (as pictured on the previous page).
 - i. Using a power drill and a 1/4" bit, drill a pilot hole at the mounting locations.
 - ii. Insert the drywall anchors into the pilot holes.
 - iii. Position the wall bracket holes over the drywall anchors.
 - iv. Insert the included screws into the drywall anchors and tighten.
 - OR install the wall bracket using a standard 3M Command Strip (not provided).

SelectBlinds™ Automation | Remote

- Slide the wall plate down over the wall bracket until it clicks into place as shown below.
- The remote then attaches to the wall plate magnetically, allowing for easy removal for handheld operation.



Programming













All remote programming is done in the app. Instructions for adding a new remote can be found in the section [“Add Remotes” on page 6](#). To update your existing remote’s programming in the app, follow the steps below.

- Navigate to “Menu” > “Accessories” > Select your remote.
- Reconfigure the remote settings for any desired group numbers.
 - The configuration page in the app shows all remote group numbers 0-5 in a carousel display.
- Choose the desired group number (1-5) and then choose the shades to assign to that group. Repeat this for all desired shades and group numbers that you want to update.
- Tap “Link” and follow the in-app instructions to synchronize the settings you created to the physical remote. When linking is complete, a “Remote linked!” message will appear in the app.
- Tap “Done” to return to the “Accessories” list.







NOTE: A maximum of 10 unique shades can be added per remote to ensure optimal performance.

Basic Operation

Remote Button Functions

Button	Icon	Function
Minus	(Minus) 	<ul style="list-style-type: none"> Press the minus button [] to switch to the previous shade group in sequence. If you are on group 0, pressing the minus button moves to group 5. The digital display will loop in sequence from 5, 4, 3, 2, 1, 0 and then back to 5.
Plus	(Plus) 	<ul style="list-style-type: none"> Press the plus button [] to switch to the next shade group in sequence. If you are on group 5, pressing [] moves to group 0. The digital display will loop in sequence from 0, 1, 2, 3, 4, 5, and then back to 0.
Favorite	(Heart Icon) 	<ul style="list-style-type: none"> Press the Favorite button [] once to move the current shade to your preset Favorite position. To link the remote (e.g., during app set-up), press and hold for ~5 seconds when prompted by the app.
Open	(Up Arrow) 	<ul style="list-style-type: none"> Press once to raise the shade to the open position. Quickly press twice for special operation for applicable product types. See product specific instructions below.
Close	(Down Arrow) 	<ul style="list-style-type: none"> Press once to lower the shade to the closed position. Quickly press twice for special operation for applicable product types. See product specific instructions below.
Left Arrow	(Left Arrow) 	<ul style="list-style-type: none"> Product specific functionality. See instructions below.
Right Arrow	(Right Arrow) 	<ul style="list-style-type: none"> Product specific functionality. See instructions below.
Stop	(Square) 	<ul style="list-style-type: none"> Press to stop shade movement.

Remote Operation for Roller and Solar Shades

- Open (Up Arrow ): Press to raise the shade to the open position.
- Close (Down Arrow ): Press to lower the shade to the closed position.
- Left Arrow (): Not Available.
- Right Arrow (): Not Available.
- Favorite (Heart ): Press to move the shade to a Favorite position. This button moves the shade to the 50% open position by default. Customize this setting in the app.
- Stop (Square ): Press to stop shade movement.

LED Display Behavior

Q: How do I wake up the remote's display?

A: The remote wakes when moved or a button is pressed. The remote displays the current group number for 5 seconds and then dims and holds the display for another 5 seconds before turning off.

Q: How will the remote display appear when linking to the shades?

A: The LED animates clockwise the "0" on the screen, and the bars light up one-by-one in a loop. When linking finishes, the full "0" lights up for 2 seconds, then turns off.

Q: How will the remote behave when updating remote firmware?

A: The LED animates in a figure-8 pattern, with lights moving in a clockwise sequence. The remote restarts automatically when the update is complete.

Q: How will the remote display behave during boot-up or reboot?

A: The LED performs a start-up sequence with symmetrical light bar animations and ends by displaying the current group number (just like normal wake-up). A boot-up occurs when batteries are inserted or after an update.

NOTE: When linking shades or checking for firmware updates, always use the app and follow on-screen instructions. No action is needed unless prompted.

Battery Replacement

Your SelectBlinds Automation remote takes 2 AAA Batteries. When your remote's display no longer lights up, it is time to replace the batteries.

1. Open the battery compartment on the back of the remote by sliding it upward, as pictured below.
2. Insert the AAA batteries, being careful to match the positive (+) end of the battery with the positive (+) terminal in the device and the negative (-) end of the battery with the negative (-) terminal in the device.
3. Slide the battery cover back into place.

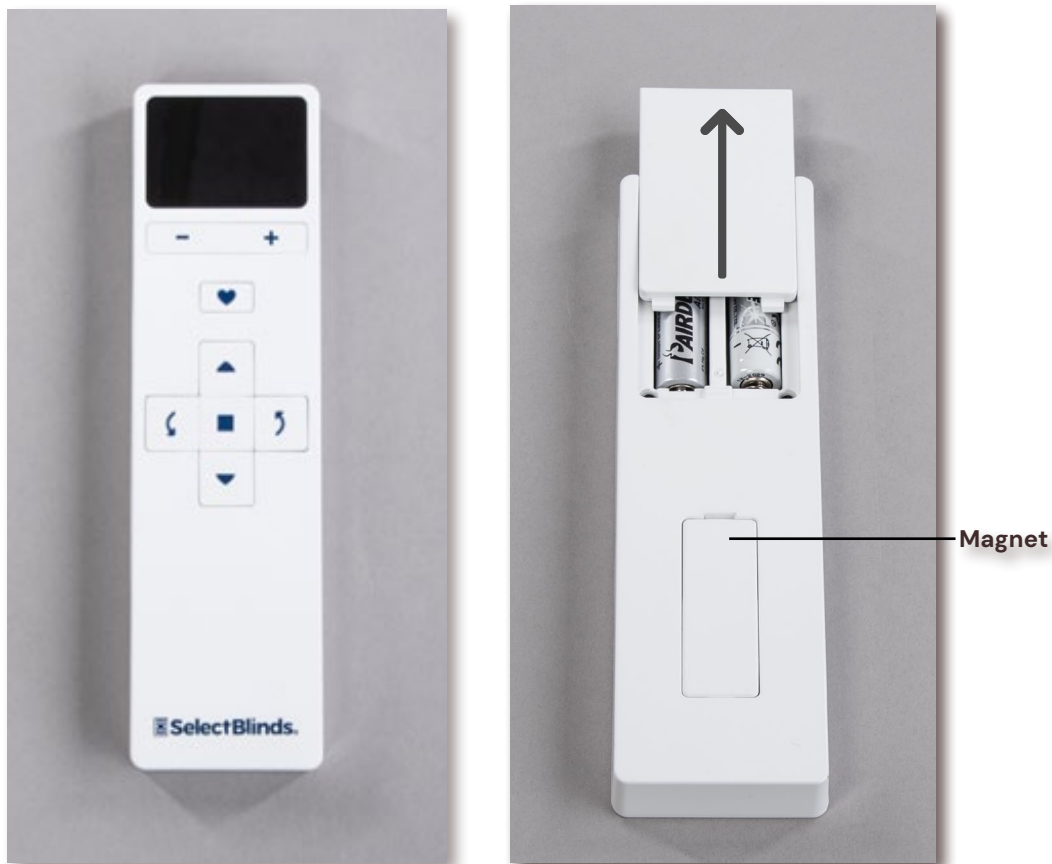

Bridge Guide

Components



View



Features

The bridge is an optional piece of hardware used to provide additional features and benefits, listed below:

- Integrates your smart shades with the popular home automation systems, enabling voice control and other smart home features.
- Allows the app to connect to your shades remotely, from anywhere in the world.
- Reduces latency for app control in larger homes.
- Extends ranges for app control in larger homes.
- Drives precise hembar alignment for more than four shades of the same type in a single room.
- Provides the best whole home control when shades are in multiple rooms.
- Ensures your Timers always stay on time and in sync, by regularly updating shade clocks.
- A single bridge can connect to up to 15 automated shades.

SelectBlinds™ Automation | Bridge

Placement in the Home

Place your bridge in a central location to all shades in the home. This will help ensure your bridge connects to every shade.

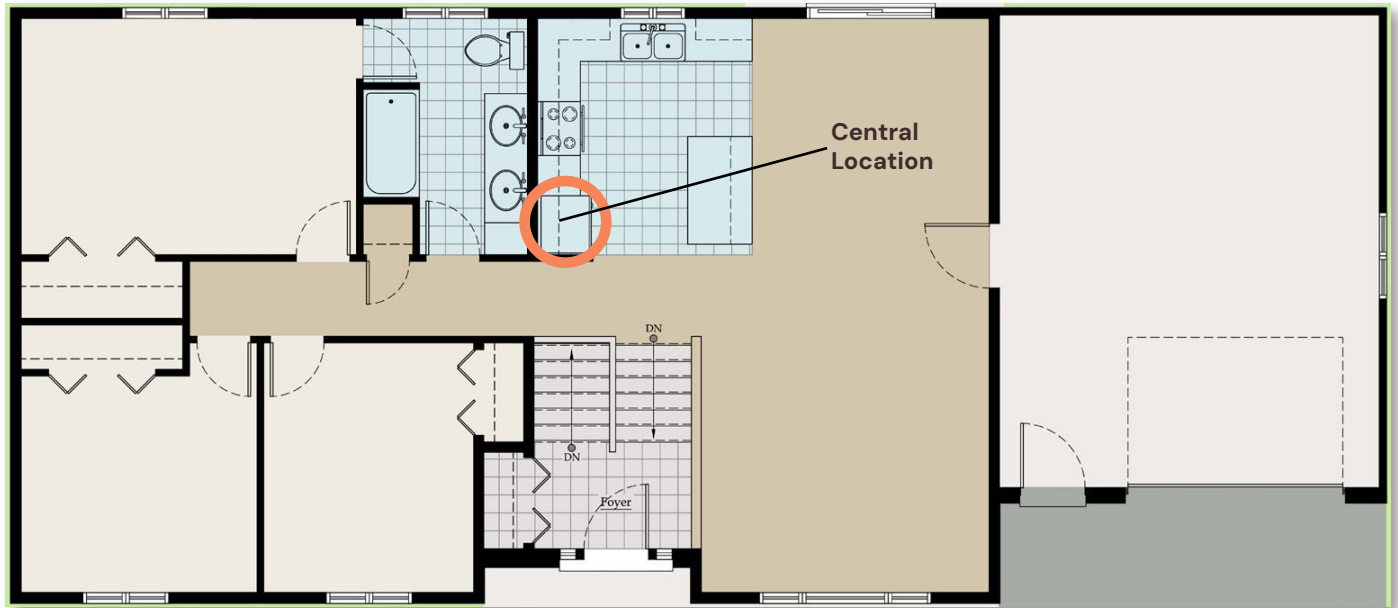

Quick Start Instructions

1. Plug in your bridge using the provided USB power cable and power adapter.
 2. During the boot-up process, the bridge's LED will display different behavior to visually communicate its status. Do not interrupt the bridge boot-up process. When the bridge LED is flashing green and purple, this indicates that it is ready to be added to the home.
 3. Follow the instructions under "Add Bridge" to add the bridge to your home in the SelectBlinds Automation App and configure the Wi-Fi network.
- ⓘ IMPORTANT:** We recommend waiting to add the bridge until **after** all shades have been added to the home. All rooms must be in range of the bridge. If some rooms are not in range, those shades will not connect successfully to the bridge. Reposition the bridge in the home and select "Try Again."

Troubleshooting

1. What do the bridge LED colors mean?
 - The light on the front of the bridge displays different colors to visually communicate its status. For example, a solid blue light indicates that the bridge is connected to the home. To view the bridge LED chart in the app, navigate to the "Menu" > "Accessories" and tap on "Bridge LED Chart."

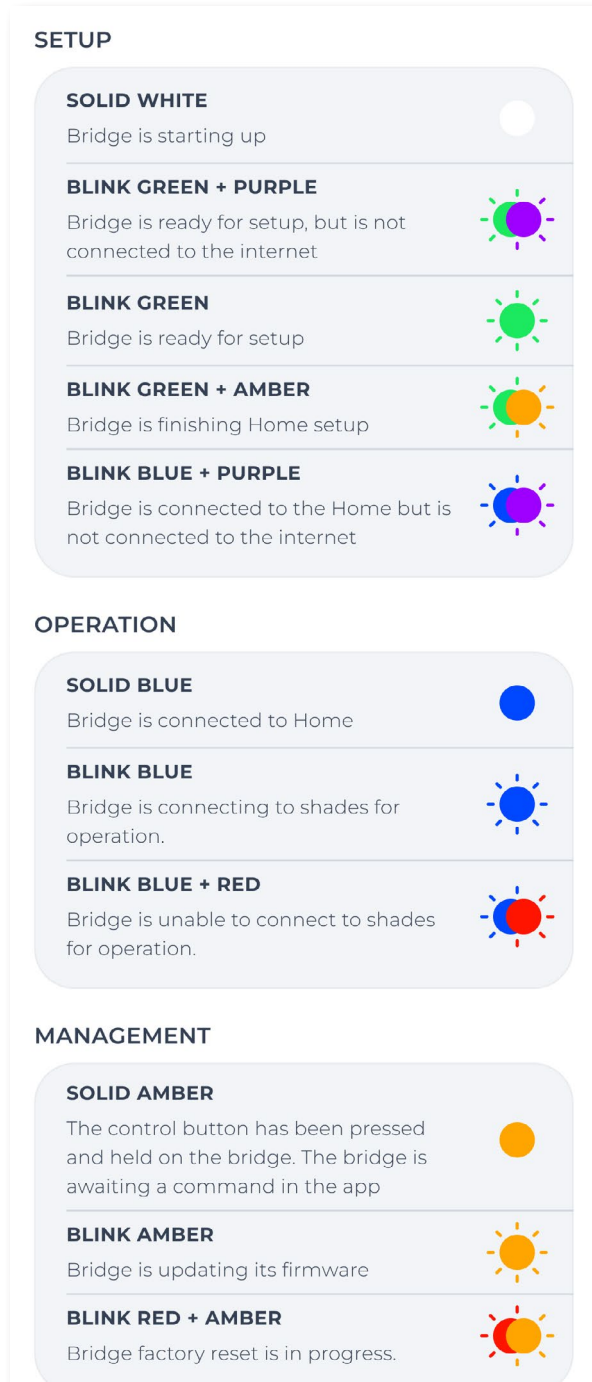

SelectBlinds™ Automation | Bridge

2. What are the functions of the buttons on the back of the bridge?
 - A. The "Primary Button" is the larger button on the left, labeled below.
 - ◇ Quick press (~2 seconds): Bridge will search for a firmware update
 - B. The "Reset Button" button is the smaller button marked with an "R."
 - i. Quick press (~2 seconds): Bridge will reboot
 - ii. Long press (~6 seconds): Bridge will factory reset



3. My Wi-Fi network does not appear in the list of available networks during the Wi-Fi configuration process. How can I fix this?
 - Select the "Refresh" button in the top-right corner of the screen and try again. If it still does not appear, select "Add Network" to manually add your Wi-Fi network.
4. How do I delete a bridge from the home?
 - A. Open the app and navigate to "Menu" > "Accessories."
 - B. Select the desired bridge, listed under "Bridges."
 - C. Tap on "Delete bridge."

Home Automation Integration

SelectBlinds Automation is compatible with Matter, an open smart home protocol that was designed to connect devices across different brands and platforms, making it easier to install and control your devices.

The Matter integration allows users to integrate with Apple Home, Google Home, and Amazon Alexa. A SelectBlinds Automation Bridge is required.



Requirements

- A SelectBlinds Automation Bridge connected to the home with the latest firmware
- The latest version of the SelectBlinds Automation App
- Check [Apple](#), [Google](#), or [Amazon Alexa](#) resources for any additional, specific requirements when adding a Matter accessory.

Matter Integration Instructions

Open the SelectBlinds Automation App and follow the steps below.

1. Select the correct home if you have more than one home.
2. Navigate to the "Menu" and select "Integrations."
3. Select "Matter."
4. Press the "Enable" button. Wait while the bridge starts accessing the Matter services. This may take a few minutes.
5. Press "View Pairing Information."
 - 📌 **IMPORTANT:** Your session will be active for approximately 10 minutes. If more time is needed, return to the previous screen and select "Enable" to restart the session.
6. On the next screen, you will see a QR code along with a manual pairing code. Highlight and copy the manual pairing code.
7. Open the desired third-party integration app to complete the setup. Use the copied manual pairing code when prompted. You may need to bypass the QR code reader to find this option.
 - A. **Apple Home:** Open the Home app on your iOS device and press the "+" button to add the bridge as an accessory.
 - B. **Google Home:** Open the Google Home app on your smartphone, navigate to "Devices," and press the "+ Add" button to add the bridge as new device.
 - C. **Amazon Alexa:** Open the Alexa app on your smartphone, navigate to the "Devices," and press the "+" button to add the bridge as a new device.

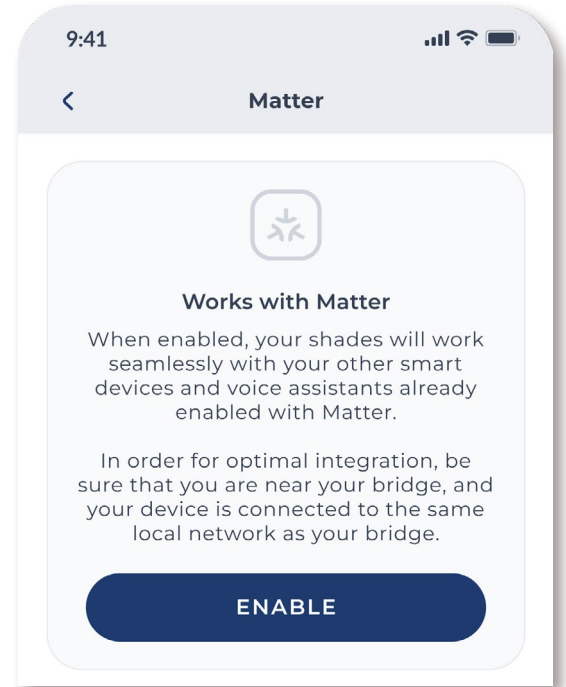

Once you have added the bridge device, the third-party app will discover any connected shades and prompt you to identify these and add them to the respective home. For more information on how to operate your shades using voice commands, along with tips and tricks for the integration of your choice, please continue reading the following sections.

Use Voice Commands to Operate Shades

Apple Home

Use voice commands to control SelectBlinds Automation window treatments using Siri-enabled devices. SelectBlinds Automation works with Siri to allow you to voice-activate individual shades, rooms of shades, or scenes created in the Apple Home app. Simply say "Hey Siri" followed by "Open," "Close," or "Activate," and then the shade name, room, or scene name. Examples of phrases to control your window treatments include:

"Hey Siri, set Living Room Left shade to 50%."

"Hey Siri, activate Good Morning."

Voice-activated scenes or operations using Siri, as well as home automations including SelectBlinds Automation shades, must be created within the Apple Home app. Existing SelectBlinds Automation Scenes and Timers will not be imported into the Home app.

Google Home

Use your voice to control your SelectBlinds Automation window treatments with a Google Home-enabled device. Simply say, "Hey Google" or "Hey Google" followed by the shade, room, or SelectBlinds Automation Scene name. Examples of phrases to control your shades include:

"OK Google, tilt Sun Room to 25 percent."

"OK Google, open Bedroom Left."

"Hey Google, close the shades."

Voice-activated scenes and automations using Google must be created within the Google Home app. Existing SelectBlinds Automation Scenes and Timers will not be imported into the Google Home app.

Amazon Alexa

Use voice commands to control your SelectBlinds Automation window treatments using Amazon Alexa-controlled devices. SelectBlinds Automation works with Alexa to allow you to voice-activate individual shades or rooms of shades. Simply say “Alexa” followed by the percentage position and then the shade name. Examples of phrases to control your window treatments include:

“Alexa, set Bedroom Left to 50%.”

“Alexa, move Office Center to 0%.”

“Alexa, set Kitchen Right to 100%.”

Voice-activated scenes and routines using Alexa must be created within the Alexa app. Existing SelectBlinds Automation Scenes and Timers will not be imported into the Alexa app.

Apple Home — Tips and Tricks

Use the following tips to interact with SelectBlinds Automation® shades via the Apple Home app:

- Existing SelectBlinds Automation Scenes and Timers will not be automatically imported into the Home app. Voice-activated scenes or operations using Siri, as well as home automations including SelectBlinds Automation shades, must be created within the Apple Home app.
- Window treatments with multiple services (Top-Down Bottom-Up) will each come into Apple Home as one shade with multiple services that should be renamed. To ensure the best experience with voice operation, we recommend doing the following:
 - For Top-Down Bottom-Up shades, we recommend changing the service names from “Blinds” and “Blinds2” to “Top” and “Bottom.” This will allow you to incorporate “Top” or “Bottom” into your voice commands.
- Products with secondary tilt control, such as Sheer Shades, will not respond to voice commands for tilt position for individual shades or groups of shades. However, creating scenes will allow voice control for these products.



Basic Touch Operation in Apple Home App

- Tap the round icon on the shade tile > toggles between open and close
- Tap outside the circle on the tile > opens a slider control
- Tap the gear icon in the slider view > accesses tilt control (for Sheer Shades)

Multi-Control Shades (Top-Down Bottom-Up) Operation in Apple Home App

- **Tap anywhere** on the tile to open two sliders:
 - One for **bottom rail**
 - One for **top rail**

Google Home — Tips and Tricks

Use the following tips to interact with SelectBlinds Automation® shades via the Google Home app:

- SelectBlinds Automation Scenes are not imported into Google Home using the Matter integration. If desired, you can recreate your Scenes as Automations in the Google Home app.
- To create Automations in the Google Home app, select “Ask Google” as the “Action,” instead of “Devices.” This will ensure that any on-demand or schedule-based Automations fire correctly. Then type in the voice command that sets the shade to the position that you desire. The command happens silently, behind the scenes.
 - Practice voice commands in advance of creating Automations, to determine the precise command language.
- We recommend adding the shades to the appropriate rooms in your Google Home app. This will automatically allow you room control and better organization, especially with a larger number of shades.
 - The SelectBlinds Automation Bridge will also be shown but not assigned to rooms. It can be assigned to a room in the same way that shades are.
- If your shades have multiple services (Top-Down Bottom-Up), these shades will come into Google Home as multiple tiles with the same name. To ensure the best experience with voice operation, we recommend renaming the services for multi-function shades, to better describe the function. Consider the details below when renaming:
 - Names are limited to 24 characters, and any names longer than this will be automatically truncated. The shortened name may cause confusion with voice commands.
 - Shade names must be unique and may not be reused for any other shade or device in the home.
 - Tile 1 is the manifest shade and has no control. Keep the original name for the manifest shade with no controls. You may also choose to place this tile in a different room to avoid confusion. It **MUST** remain in the app. (It may be necessary to activate the shade tile and watch the shade to determine whether the tile you are tapping controls the primary or secondary function.)
 - Tile 2 is the primary shade control, and will include tilt control if available. (An example that may require a rename is Bottom Rail for Top-Down Bottom-Up Shades. **Rename by adding “Bottom” at the end of the shade name.**)
 - Tile 3 is the secondary shade control, if available. (An example that may require a rename is the Top-down service for Top-Down Bottom-Up shades. **Rename this one by appending the service name “Top” to the existing shade name.**)



Amazon Alexa — Tips and Tricks

Use the following tips to interact with SelectBlinds Automation shades via the Alexa app.

- Voice-activated scenes and routines using Alexa must be created within the Alexa app. Existing SelectBlinds Automation Scenes and Timers will not be imported into the Alexa app.
- Create routines in the Alexa app to set up your shades to respond to voice commands like “open” and “close,” or to control multiple shades at once.
- Most shades come in as two devices each. Shades with multiple services (such as Top-Down Bottom-Up) will come in as three devices:
 - One device is the manifest shade and includes the shade name but no controls. (If this device is deleted, so is the shade with control. You can rediscover by using the “Discover Devices” command.)
 - The second device is the primary shade control and is named “First Blind.” If applicable, you will see a third device named “Second Blind.” (You must rename the unnamed “blinds.” We recommend that you do not use the same name as the manifest shade.)
 - Shade lift control percentages in the Alexa app are reversed from how they appear in the SelectBlinds Automation app (0% = fully open, 100% = fully closed).
 - The Alexa app does not include any vane controls for applicable products such as Sheer Shades.

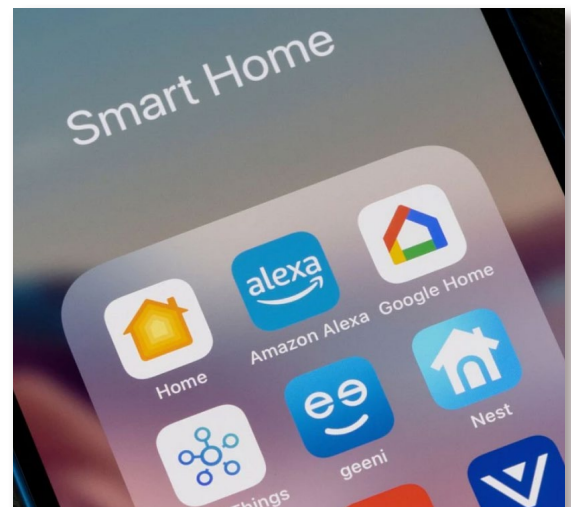

Apple and Siri are registered trademarks of Apple, Inc. Amazon and Amazon Alexa are trademarks of Amazon.com, Inc. Google Home is a trademark of Google LLC.

Declarations

Motor and Remote Declarations

FCC Compliance Statement

This device complies with part 15 of the FCC Rules. Operation is subject to the following two conditions: (1) This device may not cause harmful interference, and (2) this device must accept any interference received, including interference that may cause undesired operation.

This equipment has been tested and found to comply with the limits for a Class B digital device, pursuant to part 15 of the FCC Rules. These limits are designed to provide reasonable protection against harmful interference in a residential installation. This equipment generates, uses and can radiate radio frequency energy and, if not installed and used in accordance with the instructions, may cause harmful interference to radio communications. However, there is no guarantee that interference will not occur in a particular installation. If this equipment does cause harmful interference to radio or television reception, which can be determined by turning the equipment off and on, the user is encouraged to try to correct the interference by one or more of the following measures:

- Reorient or relocate the receiving antenna.
- Increase the separation between the equipment and receiver.
- Connect the equipment into an outlet on a circuit different from that to which the receiver is connected.
- Consult the dealer or an experienced radio/TV technician for help.

NOTE: Changes or modifications not expressly approved by the manufacturer responsible for compliance could void the user's authority to operate the equipment.

Responsible party:

SelectBlinds

One Duette Way

Broomfield, CO 80020 USA

www.selectblinds.com

ISED Canada Compliance Statement

This device contains licence-exempt transmitter(s)/receiver(s) that comply with Innovation, Science and Economic Development Canada's licence exempt RSS(s).

This Class B digital apparatus complies with Canadian ICES-003.

Operation is subject to the following two conditions: (1) This device may not cause interference. (2) This device must accept any interference, including interference that may cause undesired operation of the device.

Cet appareil contient des émetteurs/récepteurs sans licence qui sont conformes aux RSS sans licence d'Innovation, Sciences et Développement économique Canada.

Cet appareil numérique de la classe B est conforme à la norme NMB-003 du Canada.

Le présent appareil est conforme aux CNR d'ISDE Canada applicables aux appareils radio exempts de licence. L'exploitation est autorisée aux deux conditions suivantes : (1) l'appareil ne doit pas produire de brouillage, et (2) l'appareil doit accepter tout brouillage radioélectrique subi, même si le brouillage est susceptible d'en compromettre le fonctionnement du dispositif.

CE and UKCA Compliance Statement

SelectBlinds

One Duette Way

Broomfield, CO 80020, USA

SelectBlinds hereby declares that the motor and remote are in compliance with the essential requirements and other relevant provisions of Electromagnetic Compatibility (EMC) Directive 2014/30/EU and Radio Equipment Directive (RED) 2022/2380. A copy of the DoC can be obtained online: www.selectblinds.com.



Bridge Declarations

This equipment should be installed and operated with minimum distance 20cm separation from the user.

FCC Compliance Statement

This device complies with part 15 of the FCC Rules. Operation is subject to the following two conditions: (1) This device may not cause harmful interference, and (2) this device must accept any interference received, including interference that may cause undesired operation.

This equipment has been tested and found to comply with the limits for a Class B digital device, pursuant to part 15 of the FCC Rules. These limits are designed to provide reasonable protection against harmful interference in a residential installation. This equipment generates, uses and can radiate radio frequency energy and, if not installed and used in accordance with the instructions, may cause harmful interference to radio communications. However, there is no guarantee that interference will not occur in a particular installation. If this equipment does cause harmful interference to radio or television reception, which can be determined by turning the equipment off and on, the user is encouraged to try to correct the interference by one or more of the following measures:

- ◆ Reorient or relocate the receiving antenna.
- ◆ Increase the separation between the equipment and receiver.
- ◆ Connect the equipment into an outlet on a circuit different from that to which the receiver is connected.
- ◆ Consult the dealer or an experienced radio/TV technician for help.

NOTE: Changes or modifications not expressly approved by the manufacturer responsible for compliance could void the user's authority to operate the equipment.

Responsible party:

SelectBlinds

One Duette Way

Broomfield, CO 80020 USA

www.selectblinds.com

ISED Canada Compliance Statement

This device contains licence-exempt transmitter(s)/receiver(s) that comply with Innovation, Science and Economic Development Canada's licence exempt RSS(s).

This Class B digital apparatus complies with Canadian ICES-003.

Operation is subject to the following two conditions: (1) This device may not cause interference. (2) This device must accept any interference, including interference that may cause undesired operation of the device.

Cet équipement doit être installé et utilisé à une distance minimale de 20 cm de l'utilisateur.

Cet appareil contient des émetteurs/récepteurs sans licence qui sont conformes aux RSS sans licence d'Innovation, Sciences et Développement économique Canada.

Cet appareil numérique de la classe B est conforme à la norme NMB-003 du Canada.

Le présent appareil est conforme aux CNR d'ISDE Canada applicables aux appareils radio exempts de licence. L'exploitation est autorisée aux deux conditions suivantes : (1) l'appareil ne doit pas produire de brouillage, et (2) l'appareil doit accepter tout brouillage radioélectrique subi, même si le brouillage est susceptible d'en compromettre le fonctionnement du dispositif.

CE and UKCA Compliance Statement

SelectBlinds

One Duette Way

Broomfield, CO 80020, USA

SelectBlinds hereby declares that the bridge is in compliance with the essential requirements and other relevant provisions of Electromagnetic Compatibility (EMC) Directive 2014/30/EU and Radio Equipment Directive (RED) 2022/2380. A copy of the DoC can be obtained online: www.selectblinds.com.



PowerWand™ Quick Programming Guide

Honeycomb Shades, Roller/Solar Shades, Sheer Shades, and Zebra Shades

1a. Attach the PowerWand — Roller/Solar, Sheer, and Zebra Shades

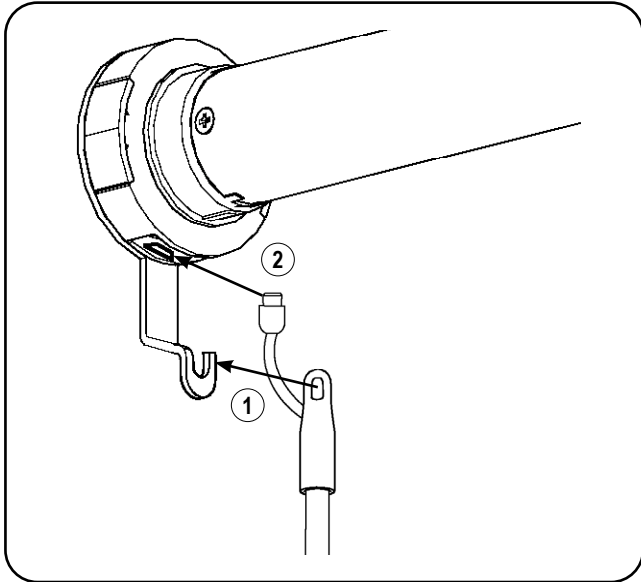

For Roller/Solar, Sheer, and Zebra Shades, with the wand control buttons facing you, attach the top of the wand on the metal hook support (1) on the motor control side, then connect the cable into the motor head (2).

1b. Attach the PowerWand — Honeycomb Shades

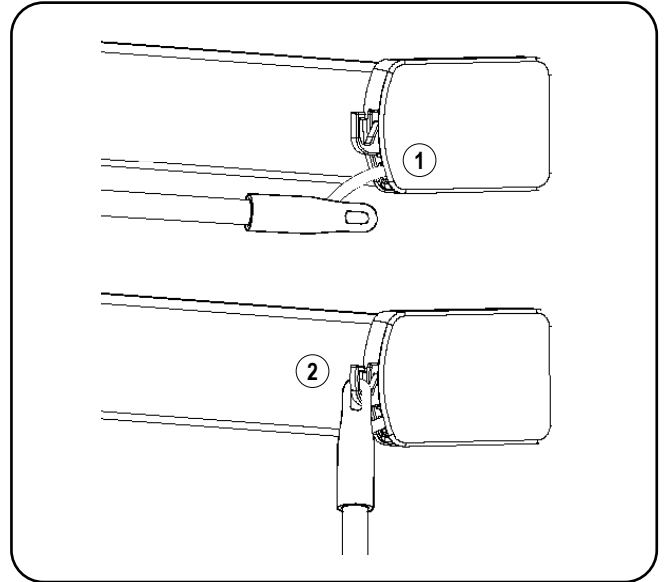

For Honeycomb shades, the wand will be already connected to the shade (1). With the wand control buttons facing you, attach the top of the wand into the plastic hook support on the motor control side (2).

IMPORTANT: Before starting the programming, install the shade following the installation instructions provided.

For Honeycomb Shades (to wake up the motor prior to operating the shade): Press the STOP button 5 times (1). The first 4 times press quickly, and the 5th time PRESS and HOLD the stop button until the motor jogs (2).

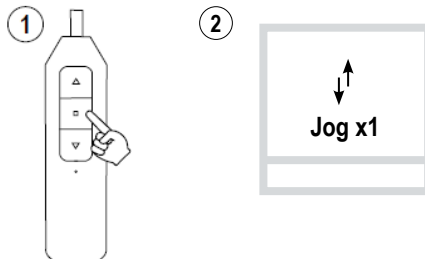

1. Operate the PowerWand

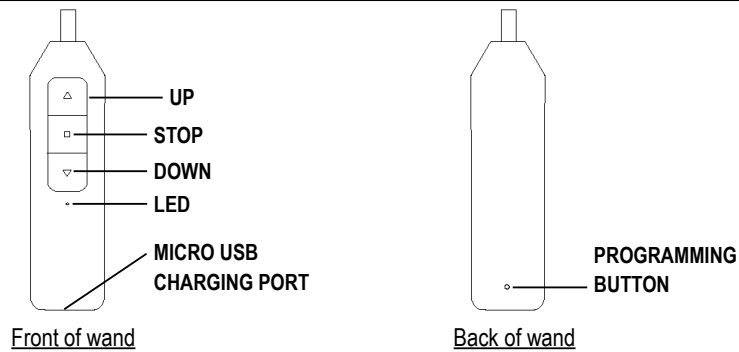

Roller/Solar and Honeycomb Mode:

- Press the **DOWN** or **UP** button to lower or raise the shade. Press the **STOP** button to stop the shade at the desired position.

Sheer Shades and Zebra Shades Mode:

- Tap the **UP** or **DOWN** button for less than 2 seconds to move the shade in short steps.
- Hold the **UP** or **DOWN** button down for more than 2 seconds before releasing to operate the shade at the standard speed.
- Press the **STOP** button to stop the shade at the desired position.

2. Set a Favorite Position

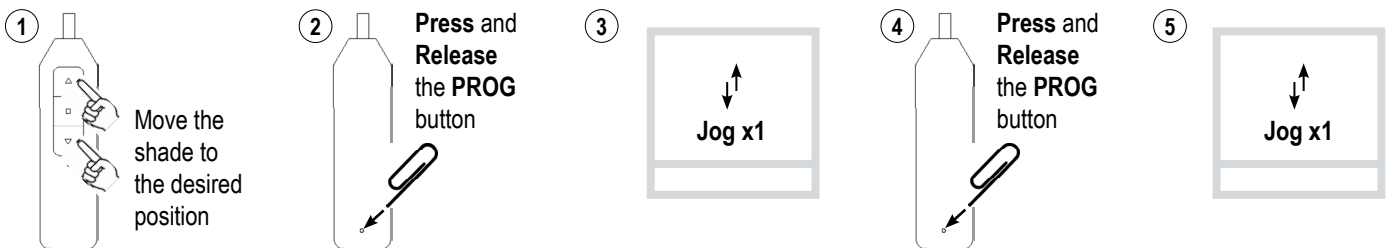

IMPORTANT: Once the Favorite Position is set, the shade will always stop at the designated Favorite Position. If you click the **UP** or **DOWN** button 2 times, the shade will go to Set Top or Bottom Limit.

3. Remove a Favorite Position



4. Perform Advanced Programming

IMPORTANT: Damage to shade may occur when operating the motor prior to setting limits. Attention should be given.

Switch Between Roller & Sheer Shades Mode

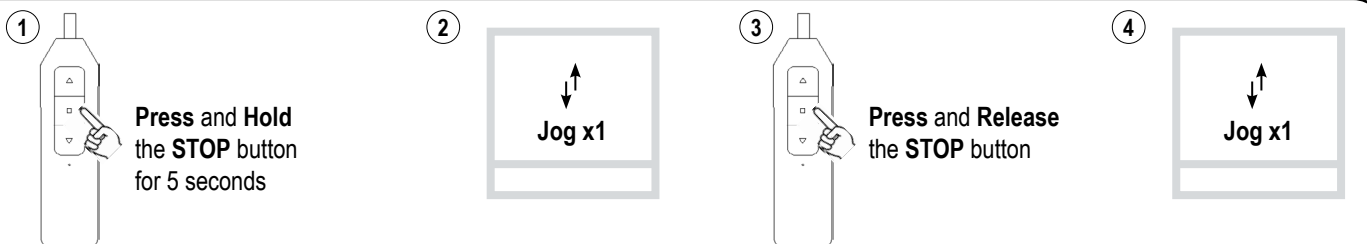

5. Adjust the Top and/or Bottom Limit

1 Move the shade to the limit that should be adjusted

2 Press and Release the PROG button

3 Jog x1

4 Adjust the shade to the desired limit position

5 Press and Release the PROG button

6 Jog x1

Factory Motor Reset

1 Press and Hold the STOP button for 5 seconds

2 Jog x1

3 Press and Hold the PROG button for 7 seconds

4 Jog x2

IMPORTANT: All limits will be erased. The motor direction will return to default and may need to be adjusted.

Reverse UP and DOWN Commands (Only if necessary)

1 Press and Hold the STOP button for 5 seconds

2 Jog x1

3 Press and Release the DOWN button

4 Jog x1

Set Upper and Lower Limits (Only after Factory Motor Reset)

1 Press and Release the PROG button

2 Jog x1

3 Press UP to set the TOP LIMIT

4 Adjust the shade to the desired top limit

5 Press and Release the PROG button

6 Jog x1

7 Adjust the shade to the desired lower limit

8 Press and Release the PROG button

9 Jog x1

10 Press and Release the PROG button

11 Jog x1

6. Charge the Battery

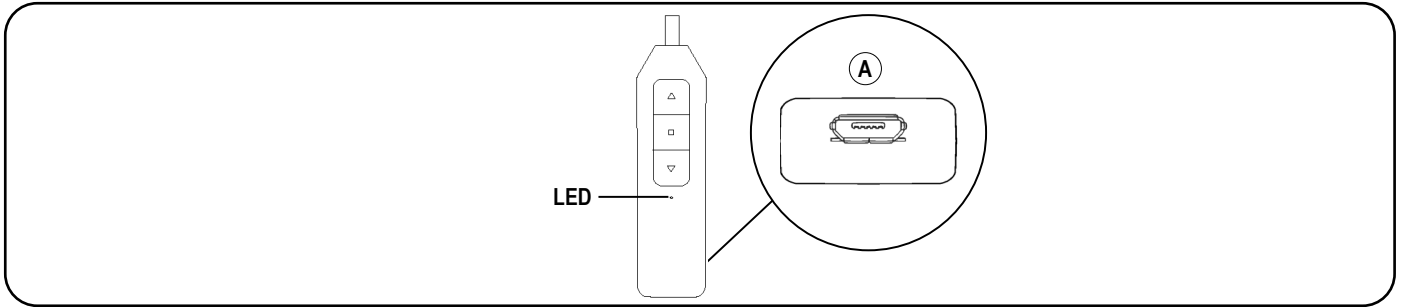

When the shade begins to operate slower than normal or only beeps when you attempt to operate, it is time to charge the battery.

To Charge, connect a standard micro USB cable into the bottom of the wand (A) and into USB 5V/2A (max) power supply. A red LED on the wand indicates that the battery is charging. To fully charge the batteries, allow the batteries to charge for at least 1 hour after the LED on the wand turns green.

Note: A typical charge cycle can take between 4-6 hours.

Troubleshooting

Issues	Possible Causes	Solution
The shade is not responding.	Built-in battery is depleted.	Recharge with compatible USB 5V/2A (max) adapter and a micro USB cable. Details under "6. Charge the Battery".
	Wand is not fully connected to the motor.	Check the connection between the wand and the motor.
The shade moves the opposite direction on the control buttons.	The motor direction is reversed.	See details under "Reverse Up and Down Commands".
The shade stops by itself before it reaches the top or bottom limit.	A favorite position was set.	See details under "4. Remove a Favorite Position".
The shade only moves in small steps after pressing the button.	The shade is operating on Sheer Shades/Zebra Shades mode.	Switch to Roller/Honeycomb mode by following the steps under "Switch between Roller and Sheer Shades Mode".
	The shade has no limit set.	See details under "Set Upper and Lower Limits".

Child Safety

WARNING/ADVERTENCIA

5.1.3 Rev. 5/18 Part 508



Window Blind Cord Can **STRANGLE** Your Child. To prevent strangulation, purchase cordless products or products with inaccessible cords.

La cuerda de la persiana puede **ESTRANGULAR** a su niño. Para evitar el estrangulamiento, compre alternativas cuerda o productos con cuerdas inaccesibles.