

# Fabric Horizontal Blinds Install Guide

## SUGGESTED TOOLS (not included)



## BEFORE YOU BEGIN YOUR INSTALLATION

Your new 2" x 2.5" Fabric Blind is custom made to your specifications from the finest fabric available. The installation should be easy and your blind will look elegant.

### Mounting Options

- Inside mount: Blind is mounted inside the window frame, either to the top of the frame or to the sides.
- Outside mount: Blind is mounted either on or outside the window frame.
- Note: Mounting screws provided are suitable for most mounting surfaces. See below for additional suggestions.
- For wallboard or plaster: Use hollow wall anchors for added support.
- For concrete, stone, brick or tile: Use an appropriate drill and appropriate anchors before fastening the screws.
- For metal surfaces: Pre-drill holes and use appropriate anchors before fastening the screws.

## PARTS

### Box Brackets

Quantity: 2

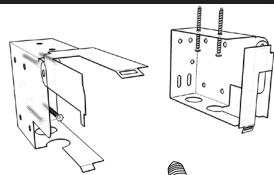

### Screws

Quantity: 8 per packet

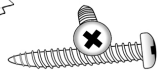

### Valance Clips

Quantity: 2 or more depending on width of blinds



## OPTIONAL PARTS

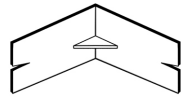

### Side Return "L" Clips

Quantity: 2

Use for outside mount returns only

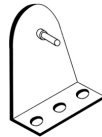

### Hold Down Brackets

To hold the bottom rail of the blind in place i.e. for a door window

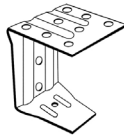

### Center Support Bracket

Use with box brackets for blinds wider than 42.5"

## 1 MOUNTING BRACKETS

- Using 4 screws per box bracket, fasten the brackets to the mounting surface. Always use 4 screws. Leave brackets in open position.

### Using Box Brackets

- **Inside mount:** Mount brackets in the corners of the frame.

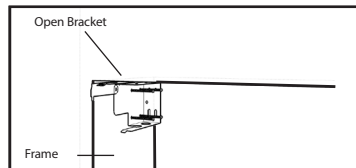

- **Outside Mount:** Outside edge of the brackets should be positioned 1/8" to outside of the headrails end mark. Mark position of the bracket as illustrated.

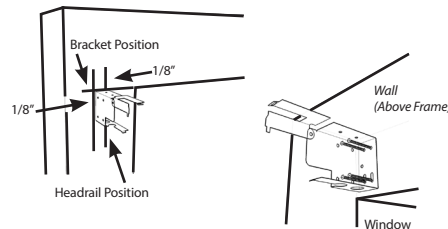

## 2 MOUNTING CENTER SUPPORT BRACKETS

(only for blinds over 42.5" wide)

- When only one center support bracket is provided, position the center bracket in the of the

two mounting brackets. The center bracket must be 2" to 3" to the right or left of center to make sure it does not interfere with mechanical components of the blind. (If more than one center bracket is provided, they should be spaced evenly between the two mounting brackets.)

- Using 4 screws per bracket, fasten the bracket(s) to your window frame or wall. For inside mount, use the top 2 holes or 4 side holes. For outside mount, use the back 4 holes.

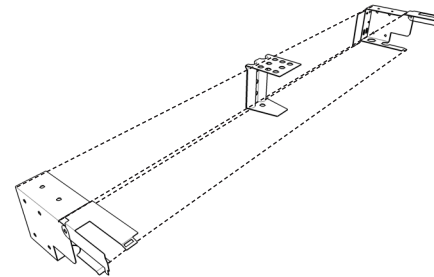

## 3 INSTALLING THE BLIND INTO THE BRACKETS

- The clips should align to the plastic channel on the back of the valance.
- Important step (Fig. A) Clip the valance clips onto the headrail. DO NOT attach valance clips to the front of the cylindrical drum location, as shown in (Fig. B). DO NOT attach the valance at this time.

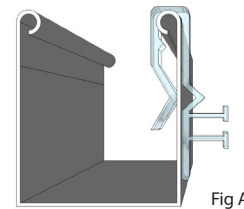

Fig A

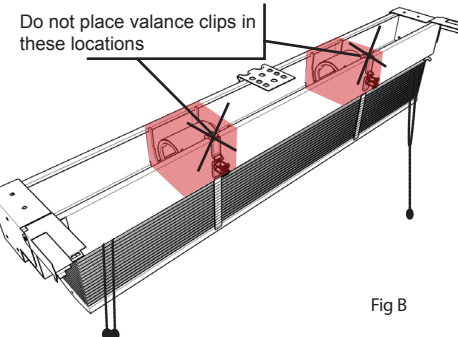
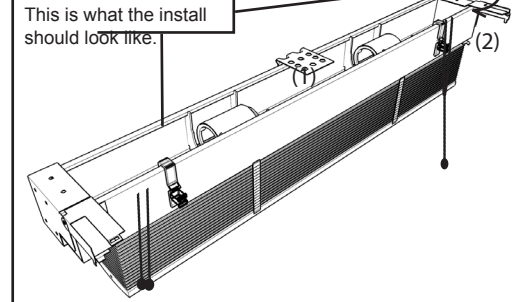

Fig B

- (Fig. C) Make sure the blind is in the closed position to make this step easier. Fit the headrail into the brackets (1) and close the swing flaps (2).

# SelectBlinds®



(2) Close Flaps

Fig C

## 4

## ATTACH THE VALANCE

- Hold the valance up to the head-rail and clip the valance to the valance clips as illustrated (Fig. D).

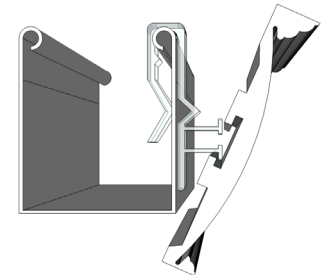

Fig D

## 5

## INSTALLING THE VALANCE SIDE RETURNS

- (See Fig. E) Locate the channel on the back of the valance and one side return, insert the plastic "L" clip in each mitered edge.
- Repeat with other side return, making sure they fit snugly together.
- Install assembly valance as illustrated in Step 4.(Fig. D)

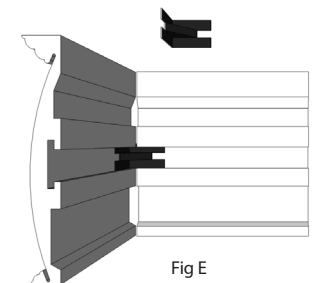
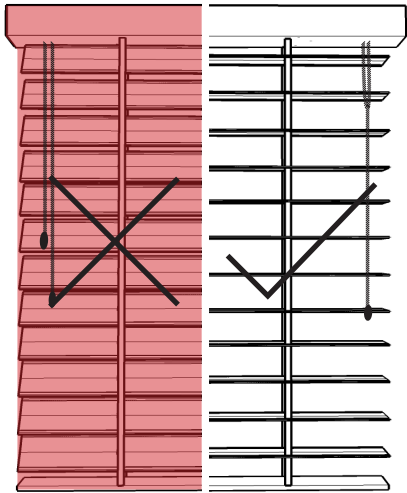

Fig E



Blind in the Closed Position    Blind in the Open Position

**Only lift blind when the fabric vanes are fully open.**

## INSTALLING HOLD DOWN BRACKETS

*(only if you have ordered hold down brackets)*

- Lower the blind to the desired height.
- Position the hold down bracket to align the tab.
- Mount the bracket using the two screws provided (see Fig. H). Insert the tab into the pre-drilled hole. To raise or lower the blind, release the bottom rail from the brackets by pulling the brackets away from the bottom rail.

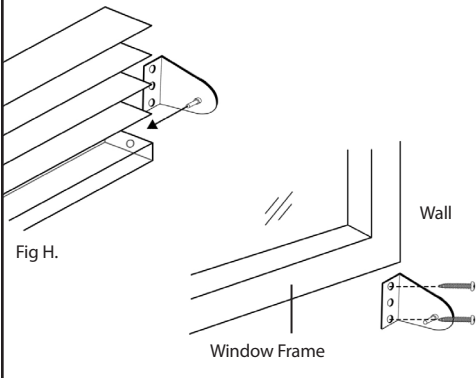

## LIMITED LIFETIME WARRANTY

The shade will be free from defects in materials and workmanship for as long as the original purchaser owns the product, provided that the product was installed properly. The limited lifetime warranty is extended to the original purchaser only, in the original window for which it was intended.

The warranty does not include any condition or damage resulting from accidents, alterations, misuse, failure to install properly, or others instances outside of Select Blinds control. This warranty also does not apply to conditions resulting from normal wear and tear.

To obtain service, contact the dealer from whom you purchased the product. Select Blinds will repair or replace defective parts or components at no charge.

This warranty is exclusive and in lieu of all other obligations, liabilities or warranties. In no event shall Select Blinds be liable for incidental or consequential damages, or for any other damage, loss or expense, cost or fees associated with such damage. In some states, exclusion for incidental or consequential damages are not allowable.

This warranty does not cover any transport, removal, or re-installation charges which may occur as a result of defects in materials or workmanship.

This warranty gives you specific legal rights, and may also have other rights, which vary from state to state.

## CARE & CLEANING

Fabric window blinds are designed with high elasticity strength. They are bendable, anti-scratch, and most importantly, water and dust resistant. They are coated with patented protective coating and can withstand most household stains; perfect for any kitchen or bathroom, and our products remain easy to clean even in rooms with high levels of moisture.

To clean, simply vacuum or dust periodically and for deeper cleaning, you can remove the blinds and wash them in your bathtub or outdoors using a garden hose and a mild detergent. Let air dry and reinstall.

## IMPORTANT SAFETY WARNING

Window cords can pose a potential strangulation hazard to young children. According to the U.S. Consumer Product Safety Commission, corded window coverings are among the top five hidden hazards in American homes. Check your window coverings for exposed or dangling cords and retrofit or replace them with today's safer products.

Never place a crib, playpen, bed or any type of low-standing furniture near a window. In exploring their surroundings, young children can accidentally fall through an open window or window screen, or become tragically entangled in a nearby window cord. Whenever possible, place cribs and furniture on a non-windowed wall.

Dangling or accessible cords on window coverings can pose an accidental strangulation hazard to infants and young children. For your safety, replace older corded window coverings with today's safer products.

The Window Covering Safety Council (WCSC) and government safety officials recommend that you only use cordless window products in homes with young children.

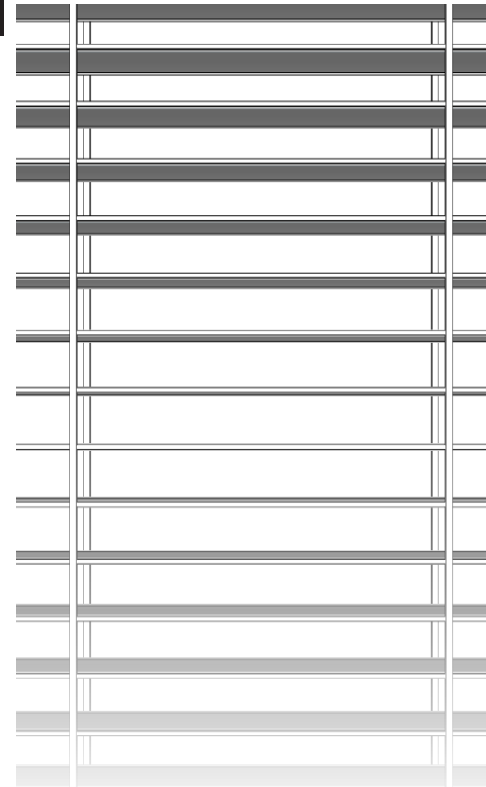

 **Select Blinds®**

**Thank you for choosing our fabric blinds for your home.**

We are confident that you will find these window blinds to be of superior quality and value, compared to other blinds on the market today.

In this guide, you will find useful information about installation, child safety, cleaning and warranty when using our blinds.

**READ ALL INSTALLATION INSTRUCTIONS  
BEFORE INSTALLATION**